



KRAUS & NAIMER
BLUE LINE SWITCHGEAR

www.krausnaimer.com

SINCE 1907

Catalog 100

CL Switches 10 A-20 A

C, CA, CAD Switches 10 A-315 A

L Switches 350 A-2400 A



KRAUS & NAIMER

The development of the Blue Line rotary switch, contactor and motor starter product ranges is based on more than seventy-five years experience by Kraus & Naimer in the design and manufacture of electrical switchgear. Kraus & Naimer pioneered the introduction of the cam operated rotary switch and continues to be recognized as the world leader in that product field.

BLUE LINE

Blue Line products are protected by numerous patents throughout the industrial world. They are built to national and international standards and designed to withstand adverse temperatures and climates.

Blue Line products are accepted and universally recognized for their quality and workmanship. They are supported by a worldwide sales and service organization.

The Kraus & Naimer Registered Trademark

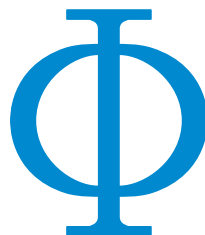

WORLDWIDE SYMBOL
FOR QUALITY SWITCHGEAR

Disconnectors and Main Switches acc. to IEC 60947-3 see Catalog 500

Contents	Page
Construction Data	2
Dimensions and Nominal Ratings	3
How to order	4, 5
Switch Function and Configuration	
CL Switches 10 A-20 A C, CA and CAD Switches 10 A-315 A	
ON/OFF Switches	6, 7
Double-throw Switches	8-10
General Application Switches	10
Coding Switches	11
Multi-step Switches	12-14
Voltmeter Switches	15-17
Ammeter Switches	17-19
Volt-ammeter Switches	19
Control Switches	19, 20
Motor Switches	21-23
L Switches 350 A-2400 A	
ON/OFF Switches	24-26
Double-throw Switches	26, 27
Multi-step Switches	27, 28
Types of Mounting	
Panel Mounting	29-33
Base Mounting	34
Wall Mounting	35
Escutcheon Plates	36, 37
Handles	38
International Standards and Approvals	39
Technical Data	40-43
Dimensions	
Panel Mounting	44-48
Base Mounting	48, 49
Wall Mounting	50
Overall Switch Lengths	50, 51
Blue Line Switchgear: Summary	52

Construction Data

The load switches of the C, CA, CAD and CL-series offer a solution for most cam switch applications. Different contact designs, contact materials and terminals allow for their use as control switches, instrumentation switches and motor control switches, as well as in electronic circuitry and in aggressive environments according to IEC 60947-3 and VDE 0660 part 107.

The stage is the basis for all switches and can be supplied with a maximum of 2 contacts. The terminals are accessible from the side. CA and CAD switches are supplied with open terminals to facilitate wiring and are protected against accidental finger contact according to EN 50274, VDE 0660 part 514 and BGV A2. Captive plus-minus terminal screws and integrated screwdriver guides also reduce wiring.

The switches of the new CL-series are supplied with IDC terminals (Insulation Displacement Connection) instead of the conventional screw type terminals. The stripping or preparation of the insulation is no longer required. Eliminate errors due to i.e., stripped end of the conductor too long or too short, incorrect sleeves used, sleeves crimped incorrectly or wrong crimping tool is used, terminal screws not tightened properly etc. The CL switches reduce installation time by 60 %-70 % compared to the screw type terminals. This translates to significant cost savings. For connecting 2 conductors to a terminal an additional screw terminal with plus-minus screw is available.

If a positive manual operation or a higher DC rating is required, many of these switches can be fitted with a snap action latching mechanism - suffix „S“ - to the switch type.

The cam-operated switches L350-L2000 are continuous current rated for off-load switching. They may be used to switch resistive or low inductive loads.

Special Contact Systems

CA4/CA4-1

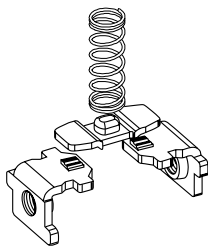

High contact reliability by multiple cross-point contacts, electronic compatible, CA4 with 1 μ and CA4-1 with 35 μ gold plating.

CAD11/CAD12

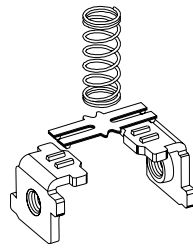

H-bridge with „cross-wire“ contact system, high contact reliability also at lower voltages. CAD11 with gold-plated contacts, CAD12 with silver contact.

Type	Size	Possible Switching Angles	Max. No. of Stages
CA4, CA4-1	S00	30°, 45°, 60°, 90°	9
CL4	S00	30°, 45°, 60°, 90°	8
CA10-CA25	S0	30°, 45°, 60°, 90°	12
CA10S-CA25S	S0	60°	on request
CAD11, CAD12	S0	30°, 45°, 60°, 90°	12
CL10	S0	30°, 45°, 60°, 90°	10
CA10B-CA25B	S1	30°, 45°, 60°, 90°	12
C26, C32, C42	S1	20°, 30°, 45°, 60°, 90°	12
C26S, C32S, C42S	S1	60°	on request
C43, C80, C125	S2	20°, 30°, 45°, 60°, 90°	12
C315	S3	20°, 30°, 45°, 60°, 90°	12
L350/51, L630/31, L1000/01, L1250/51	S2	30°, 45°, 60°, 90°	12
L400, L600, L800, L1200, L1600, L2000	S3	30°, 45°, 60°, 90°	12

CL Switches



CA and CAD Switches



C Switches



L Switches



Above illustrates the standard terminal positions.

Nominal Ratings

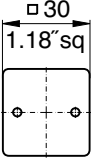
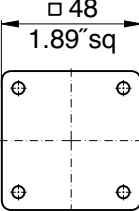
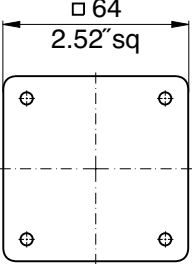
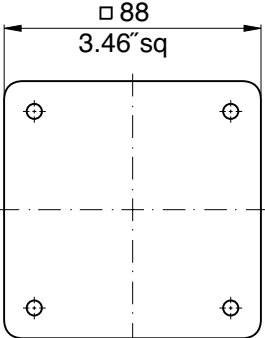
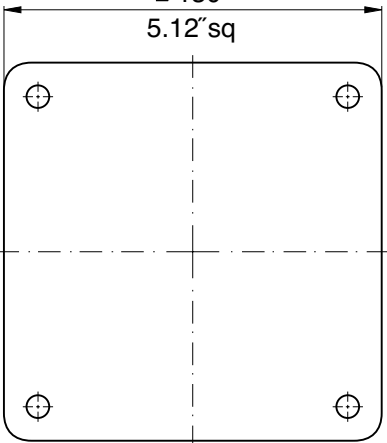
Switch Size	Type	According to IEC 60947-3/VDE 0660 part 107			
		Insulation Voltage ¹ U_i V	Thermal Current I_U/I_{th} A	Motor Rating 3 x 380 V-440 V AC-23 AC-3 kW kW	
S00 	CA4	440	10	3	2,2
	CA4-1	440	10	3	2,2
	CL4	440	10	3	2,2
S0 	CA10	690	20	7,5	5,5
	CA11	690	20	7,5	5,5
	CA20	690	25	11	7,5
	CA25	690	32	15	11
	CAD11	600	6	-	-
	CAD12	600	6	-	-
	CL10	690	20	7,5	5,5
S1 	CA10B	690	20	7,5	5,5
	CA11B	690	20	7,5	5,5
	CA20B	690	25	11	7,5
	CA25B	690	32	15	11
	C26	690	32	15	11
	C32	690	50	22	15
	C42	690	63	30	18,5
S2 	C43	690	63	30	18,5
	C80	690	115	45	30
	C125	690	150	75	37
	L350	690	350	90	37
	L351	690	350	90	37
	L630	690	630 ²	90	37
	L631	690	630 ²	90	37
	L1000	690	1000 ²	90	37
	L1001	690	1000 ²	90	37
	L1250	690	1250 ²	90	37
L1251	690	1250 ²	90	37	
S3 	C315	690	315	132	55
	C316³	1000	315	132	55
	L400	690	500	132	55
	L600	690	800 ²	132	55
	L800	690	1100 ²	132	55
	L1200	690	1450 ²	132	55
	L1600	690	1900 ²	132	55
	L2000	690	2400 ²	132	55

For further technical details, refer to pages 40-43.
To furnish with gold contacts and quick connects see page 4.

¹Valid for lines with grounded common neutral termination, overvoltage category III, pollution degree 3. Values for other supply systems on request. ²Ambient temperature 35 °C max. ³Additional switch functions on request.

How to order

Disconnectors and Main Switches according to IEC 60947-3 see Catalog 500

Three types of data (shown below) are required for ordering Blue Line cam-operated switches. Code numbers for ordering are shown in this catalog.

1. Type of Switch

The type of switch required may be easily selected by referring to the table on page 3 which shows the thermal current, power rating and dimensions of each switch. For further technical details, refer to pages 40-43. Variations of contacts and terminals are shown below.

2. Switch Function

The code numbers for standard switches shown on pages 6-28 indicate the switch function, escutcheon plate, handle and any optional extras.

Additional coding to modify type and color of handle and escutcheon plate is explained below.

3. Type of Mounting

Types of mounting are shown on pages 29-35. Catalog **101** describes enclosures and optional extras.

Specify the mounting code to indicate required mounting.

CA10

A202-600

VE

Type of Switch

Extending the switch type coding the following combinations will define:

Amendment	Definition	For switch types
-1	with gold contacts ¹	CA10, CA11, CA10B, CA11B
-4	with quick connects	CA4
B	S0 switches with latching mechanism size S1	CA10, CA11, CA20, CA25, CAD12
C	S1 switches with latching mechanism size S2	C26, C32
L	with lockout-relay w/o manual release for std. sw.	CA10, C26, C32, C42
M	with lockout-relay with manual release for std. sw.	C26, C32, C42
X	with power failure release	CA10, CA11, CA20, CA25, CAD12, C26, C32, C42
Y	with power failure release and trip-free release	CA10, CA11, CA20
S	with snap action	CA10, CA11, CA20, CA25, C26, C32, C42 with 60° switching
R	with spring return latching mechanism	CA10

Example: Coding for switch type **CA10** with gold contacts is **CA10-1**.

Modification of Switches

The part number for switch function and options may be modified in cases where items are required other than standard. The modification may involve the escutcheon plate inscription, color combination of escutcheon plate and handle, type of escutcheon plate and handle or the optional extra.

Switch Size	Escutcheon Plate Frame	Handle	Escutcheon Plate Backing	Escutcheon Plate Lettering	Dash Number
S0, S1, S2, S3	electro-gray	electro-gray	brushed alu	black	-100
S0, S1, S2, S3	electro-gray	electro-gray	black	mat silver	-500
S00, S0, S1, S2, S3	black	black	brushed alu	black	-600
S00, S0, S1, S2, S3	black	black	black	mat silver	-700

¹Technical data on request.

Function	Escutch. Plate	Type/Handle				Code	Stages	Connection Diagram
		CA4 CA4-1 CL4	CAD.. CA10- CA25 CL10	CA10B- CA25B	C26- C315			

ON/OFF Switches with 60° Switching

1 pole						A200-600	1	
2 pole						A201-600	1	
3 pole						A202-600	2	
3 pole with red handle						A202-626	2	
3 pole with V850 padlock attachment						A202-627	2	
4 pole						A203-600	2	
4 pole 1 pole preclose 6° ¹						A653-600	2	
5 pole						A341-600	3	
6 pole						A342-600	3	
7 pole						A343-600	4	
8 pole						A344-600	4	
8 pole 2 pole preclose 6° ¹						A654-600	4	
9 pole					A345-600	5		
10 pole					A346-600	5		
11 pole					A347-600	6		
12 pole					A348-600	6		
1 pole						A200-620	1	
2 pole						A201-620	1	
3 pole						A202-620	2	
4 pole						A203-620	2	
4 pole 1 pole preclose 6° ¹						A653-620	2	
5 pole						A341-620	3	
6 pole						A342-620	3	
7 pole						A343-620	4	
8 pole						A344-620	4	
8 pole 2 pole preclose 6° ¹						A654-620	4	
9 pole						A345-620	5	
10 pole						A346-620	5	
11 pole					A347-620	6		
12 pole					A348-620	6		
1 pole						A200-621	1	
2 pole						A201-621	1	
3 pole						A202-621	2	
4 pole						A203-621	2	
4 pole 1 pole preclose 6° ¹						A653-621	2	
5 pole						A341-621	3	
6 pole					A342-621	3		
1 pole						A200-622	1	
2 pole						A201-622	1	
3 pole						A202-622	2	
4 pole						A203-622	2	
4 pole 1 pole preclose 6° ¹						A653-622	2	
5 pole						A341-622	3	
6 pole					A342-622	3		
1 pole						A200-623	1	
2 pole						A201-623	1	
3 pole						A202-623	2	
4 pole						A203-623	2	
4 pole 1 pole preclose 6° ¹						A653-623	2	
5 pole						A341-623	3	
6 pole					A342-623	3		
1 pole						A200-624	1	
2 pole						A201-624	1	
3 pole						A202-624	2	
4 pole						A203-624	2	
4 pole 1 pole preclose 6° ¹						A653-624	2	
5 pole						A341-624	3	
6 pole					A342-624	3		
1 pole						A200-625	1	
2 pole						A201-625	1	
3 pole						A202-625	2	
4 pole						A203-625	2	
4 pole 1 pole preclose 6° ¹						A653-625	2	
5 pole						A341-625	3	
6 pole					A342-625	3		

¹for use in a three phase four-wire system with switched neutral

Switch Function and Configuration

C, CA, CAD, CL Switches

Function	Escutch. Plate	Type/Handle				Code	Stages	Connection Diagram
		CA4 CA4-1 CL4	CAD.. CA10- CA25 CL10	CA10B- CA25B	C26- C315			

ON/OFF Switches with 90° Switching

1 pole contacts							A290-600	1	<p>1, 2, 3, 4, 5 and 6 pole</p>
2 pole preclose 30°							A291-600	1	
3 pole							A292-600	2	
4 pole							A324-600	2	
4 pole 1 pole preclose 60°							A293-600	2	
4 pole 3 pole preclose 30°							A327-600	2	
5 pole contacts							A325-600	3	<p>4 pole 3 pole preclose 30°</p>
6 pole preclose 30°							A326-600	3	
1 pole contacts							A290-620	1	<p>4 pole 1 pole preclose 60°</p>
2 pole preclose 30°							A291-620	1	
3 pole							A292-620	2	
4 pole							A324-620	2	<p>4 pole 3 pole preclose 30°</p>
4 pole 1 pole preclose 60°							A293-620	2	
4 pole 3 pole preclose 30°							A327-620	2	
5 pole contacts							A325-620	3	<p>4 pole 3 pole preclose 30°</p>
6 pole preclose 30°							A326-620	3	
3 pole 360° rotation	 						A208-600	2	
							A208-620	2	
3 pole for foot operation							A386-600	2	

ON/OFF Switches with 30° Switching

1 pole							A100-600	1	<p>1-4 pole</p>
2 pole							A101-600	1	
3 pole							A102-600	2	
4 pole							A103-600	2	
1 pole with spring return							A204-600	1	<p>1-4 pole</p>
2 pole with spring return							A205-600	1	
3 pole with spring return							A206-600	2	
4 pole with spring return							A207-600	2	
1 pole with spring return							A204-620	1	<p>1-4 pole</p>
2 pole with spring return							A205-620	1	
3 pole with spring return							A206-620	2	
4 pole with spring return							A207-620	2	

¹not available for switch type CA25

Function	Escutch. Plate	Type/Handle				Code	Stages	Connection Diagram
		CA4 CA4-1 CL4	CAD.. CA10- CA25 CL10	CA10B- CA25B	C26- C315			

Double-throw Switches without „OFF“ 60° Switching

1 pole						A220-600	1	
2 pole		A221-600	2					
3 pole		A222-600	3					
4 pole		A223-600	4					
4 pole 1 pole preclose 6° ³		A673-600	4					
5 pole		A369-600	5					
6 pole		A370-600	6					
7 pole		A371-600	7					
8 pole		A372-600	8					
8 pole 2 pole preclose 6° ³		A972-600	8					
9 pole		A373-600	9					
10 pole		A374-600	10					
11 pole	A375-600	11						
12 pole	A376-600	12						

Double-throw Switches without „OFF“ with electrically isolated contacts

1 pole						A720-600	1	
2 pole		A721-600	2					
3 pole		A722-600	3					
4 pole		A723-600	4					
4 pole 1 pole preclose 6° ³		A973-600	4					
1 pole with spring return						A795-600	1	

Double-throw Switches without „OFF“ 30° Switching

1 pole						A120-600	1	
2 pole		A121-600	2					
3 pole		A122-600	3					
4 pole		A123-600	4					
1 pole with spring return						A295-600	1	
2 pole with spring return		A296-600	2					
3 pole with spring return		A297-600	3					
1 pole with spring return						A295-620	1	
2 pole with spring return		A296-620	2					
3 pole with spring return		A297-620	3					

¹not available for switch type CA25 ²not available for switch type CL4 ³for use in a three phase four-wire system with switched neutral
⁴not available for switch type CL10

Switch Function and Configuration

C, CA, CAD, CL Switches

Function	Escutch. Plate	Type/Handle				Code	Stages	Connection Diagram
		CA4 CA4-1 CL4	CAD.. CA10- CA25 CL10	CA10B- C43	C80- C315			

Double-throw Switches with Center „OFF“ 60° Switching

1 pole 2 pole 3 pole 4 pole 4 pole 1 pole preclose 6° ³ 5 pole 6 pole 7 pole 8 pole 8 pole 2 pole preclose 6° ³						A210-600 A211-600 A212-600 A213-600 A913-600 A361-600 A362-600 A363-600 A364-600 A664-600	1 2 3 4 4 5 6 7 8 8	
1 pole 2 pole 3 pole 4 pole 4 pole 1 pole preclose 6° ³ 5 pole 6 pole 7 pole 8 pole 8 pole 2 pole preclose 6° ³						A210-620 A211-620 A212-620 A213-620 A913-620 A361-620 A362-620 A363-620 A364-620 A664-620	1 2 3 4 4 5 6 7 8 8	
1 pole 2 pole 3 pole						A210-621 A211-621 A212-621	1 2 3	
1 pole 2 pole 3 pole						A210-622 A211-622 A212-622	1 2 3	
1 pole 2 pole 3 pole						A210-623 A211-623 A212-623	1 2 3	
1 pole 2 pole 3 pole 4 pole 4 pole 1 pole preclose 6° ³						A210-624 A211-624 A212-624 A213-624 A913-624	1 2 3 4 4	

Double-throw Switches with Center „OFF“ 90° Switching

1 pole 2 pole 3 pole 4 pole 1 pole preclose 60°						A218-600 A219-600 A299-600 A294-600	1 2 3 4	
1 pole 2 pole 3 pole 4 pole 1 pole preclose 60°						A218-620 A219-620 A299-620 A294-620	1 2 3 4	

Double-throw Switches with Center „OFF“ and electrically isolated contacts

1 pole 2 pole 3 pole 4 pole 4 pole 1 pole preclose 6° ³						A710-600 A711-600 A712-600 A713-600 A963-600	1 2 3 4 4	
1 pole with spring return 2 pole to center						A714-600 A715-600	1 2	

¹switch type C315 with handle ²not available for switch type C315 ³for use in a three phase four-wire system with switched neutral

Function	Escutch. Plate	Type/Handle				Code	Stages	Connection Diagram
		CA4 CA4-1 CL4	CAD.. CA10- CA25 CL10	CA10B- CA25B	C26- C315			

Double-throw Switches with Spring Return to Center

1 pole with spring return to center						A214-600	1	<p>1-3 pole</p>
2 pole						A215-600	2	
3 pole						A216-600	3	
1 pole with spring return from left to center						A214-620	1	<p>1-3 pole</p>
2 pole						A215-620	2	
3 pole						A216-620	3	
1 pole with spring return from left to center						A320-600	1	<p>1-3 pole</p>
2 pole						A321-600	2	
3 pole						A322-600	3	
1 pole						A320-621	1	<p>1-3 pole</p>
2 pole						A321-621	2	
3 pole						A322-621	3	

General Application Switches

1 pole 2 Gang						A310-600	1	<p>1 pole</p>	
2 pole						A312-600	2		<p>2 pole</p>
3 pole						A314-600	3		
1 pole						A310-620	1	<p>1 pole</p>	
2 pole						A312-620	2		<p>2 pole</p>
3 pole						A314-620	3		
1 pole 3 Gang						A311-600	2	<p>1 pole</p>	
2 pole						A313-600	3		<p>2 pole</p>
3 pole						A315-600	5		
1 pole						A311-620	2	<p>1 pole</p>	
2 pole						A313-620	3		<p>2 pole</p>
3 pole						A315-620	5		
1 pole 2 Gang						A330-600	1	<p>1 pole</p>	
2 pole						A331-600	2		<p>2 pole</p>
3 pole						A332-600	3		
1 pole						A330-620	1	<p>1 pole</p>	
2 pole						A331-620	2		<p>2 pole</p>
3 pole						A332-620	3		
2 pole 2 Gang						A339-600	2		
Series-parallel Switching						A339-620	2		
Switching sequence: 0, A+B series, A, A+B parallel						A339-600	2		
						A339-620	2		

Switch Function and Configuration

C, CA, CAD, CL Switches

Function	Escutch. Plate	Type/Handle				Code	Stages	Connection Diagram
		CA4 CA4-1 CL4	CA10 CAD11 CAD12 CL10	CA10B- CA25B	C26- C315			

Coding Switches/Binary Code

0 - 7 360° rotation					A540-600	2	
0 - 7 complement 360° rotation					A541-600	2	
0 - 7 + complement 360° rotation					A542-600	3	
0 - 9					A550-600	2	
0 - 9 complement					A551-600	2	
0 - 9 + complement					A552-600	4	
0 - 11 360° rotation					A543-600	2	
0 - 11 + complement 360° rotation					A545-600	4	

Function	Escutch. Plate	Type/Handle				Code	Stages	Connection Diagram
		CA4 CA4-1 CL4	CAD.. CA10- CA25 CL10	CA10B- C43	C80- C315			

Multi-step Switches without „OFF“

1 pole 3 Step 2 pole 3 pole 4 pole 5 pole 6 pole						A230-600 A250-600 A270-600 A476-600 A484-600 A489-600	2 3 5 6 8 9	 1 pole 2 pole 3 pole 4- and 5 pole 6 pole
1 pole 4 Step 2 pole 3 pole 4 pole 5 pole 6 pole						A231-600 A251-600 A271-600 A477-600 A485-600 A490-600	2 4 6 8 10 12	 1-3 pole 4-6 pole
1 pole 5 Step 2 pole 3 pole 4 pole						A232-600 A252-600 A272-600 A478-600	3 5 8 10	 1-4 pole
1 pole 6 Step 2 pole 3 pole						A233-600 A253-600 A273-600	3 6 9	 1 and 2 pole 3 pole
1 pole 7 Step 2 pole 3 pole						A234-600 A254-600 A274-600	4 7 11	 1-3 pole
1 pole 8 Step 2 pole 3 pole						A235-600 A255-600 A275-600	4 8 12	 1-3 pole
1 pole 9 Step						A236-600	5	 1 pole
1 pole 10 Step						A237-600	5	 1 pole
1 pole 11 Step						A238-600	6	 1 pole
1 pole 12 Step 1 pole 360° rotation						A239-600 A639-600	6 6	 1 pole

1switch type C315 with handle 2not available for switch type CL4 3not available for switch type CA11B 4not available for switch type CL10

Switch Function and Configuration

C, CA, CAD, CL Switches

Function	Escutch. Plate	Type/Handle				Code	Stages	Connection Diagram
		CA4 CA4-1 CL4	CAD.. CA10- CA25 CL10	CA10B- C43	C80- C315			

Multi-step Switches without „OFF“ with electrically isolated contacts

1 pole 3 Step						A730-600	2	 1 pole 2 pole
2 pole						A750-600	3	 1 pole 2 pole
1 pole 4 Step						A731-600	2	 1 pole 2 pole
2 pole						A751-600	4	 1 pole 2 pole

Multi-step Switches with „OFF“

1 pole 2 Step						A240-600	1	 1-6 pole
2 pole						A260-600	2	
3 pole						A280-600	3	
4 pole						A480-600	4	
5 pole						A486-600	5	
6 pole						A491-600	6	
1 pole						A240-620	1	1-6 pole
2 pole						A260-620	2	
3 pole						A280-620	3	
4 pole						A480-620	4	
5 pole						A486-620	5	
6 pole						A491-620	6	
1 pole 3 Step						A241-600	2	 1 and 2 pole
2 pole						A261-600	3	
3 pole						A281-600	5	
4 pole						A481-600	6	
5 pole						A487-600	8	
1 pole						A241-620	2	3 pole
2 pole						A261-620	3	
3 pole						A281-620	5	
4 pole						A481-620	6	
5 pole						A487-620	8	
1 pole						A241-621	2	4 pole
2 pole						A261-621	3	
								 5 pole

Function	Escutch. Plate	Type/Handle				Code	Stages	Connection Diagram
		CA4 CA4-1 CL4	CAD.. CA10- CA25 CL10	CA10B- C43	C80- C315			

Multi-step Switches with „OFF“

1 pole 4 Step 2 pole 3 pole 4 pole						A242-600 A262-600 A282-600 A482-600	2 4 6 8	
1 pole 4 Step 2 pole 3 pole 4 pole						A242-620 A262-620 A282-620 A482-620	2 4 6 8	1-4 pole
1 pole 5 Step 2 pole 3 pole						A243-600 A263-600 A283-600	3 5 8	
1 pole 5 Step 2 pole 3 pole						A243-620 A263-620 A283-620	3 5 8	1-3 pole
1 pole 6 Step 2 pole 3 pole						A244-600 A264-600 A284-600	3 6 9	
1 pole 6 Step 2 pole 3 pole						A244-620 A264-620 A284-620	3 6 9	1-3 pole
1 pole 7 Step 2 pole						A245-600 A265-600	4 7	
1 pole 7 Step 2 pole						A245-620 A265-620	4 7	1 pole 2 pole
1 pole 8 Step						A246-600	4	
1 pole 8 Step						A246-620	4	
1 pole 9 Step						A247-600	5	
1 pole 9 Step						A247-620	5	
1 pole 10 Step						A248-600	5	
1 pole 10 Step						A248-620	5	
1 pole 11 Step 1 pole 360° rotation						A249-600 A649-600	6 6	
1 pole 11 Step 1 pole 360° rotation						A249-620 A649-620	6 6	

¹not available for switch type CL4

Switch Function and Configuration

C, CA, CAD, CL Switches

Function	Escutch. Plate	Type/Handle				Code	Stages	Connection Diagram
		CA4 CA4-1 CL4	CA10- CA25	CAD.. CL10	CA10B- CA25B			

Voltmeter Switches without „OFF“

3 phase 3 wire						A023-600	2	
						A023-620	2	
3 phase 3 wire 3 phase to phase and phase to neutral						A025-600	3	
						A025-620	3	

Voltmeter Switches with „OFF“

2 pole 360° rotation						A002-600	1	
3 phase 3 wire						A004-600	2	
						A004-620	2	
						A004-621	2	
						A004-622	2	
						A004-623	2	
						A004-624	2	
						A011-600	2	

Function	Escutch. Plate	Type/Handle				Code	Stages	Connection Diagram
		CA4 CA4-1 CL4	CA10- CA25	CAD.. CL10	CA10B- CA25B			

Voltmeter Switches with „OFF“

3 phase to neutral						A005-600	2	
						A005-620	2	
						A005-621	2	
						A005-622	2	
						A005-623	2	
3 phase to phase and 3 phase to neutral						A007-600	3	
						A007-620	3	
						A007-621	3	
						A007-622	3	
						A007-623	3	
						A007-624	3	
2 separate 3 phase with center „OFF“						A008-600	4	
						A008-620	4	
						A008-621	4	
						A008-622	4	

Switch Function and Configuration

C, CA, CAD, CL Switches

Function	Escutch. Plate	Type/Handle	Code	Stages	Connection Diagram
	CA4 CA4-1 CL4	CAD. CA10- CA25 CL10	CA10B- C32	C43- C125	

Voltmeter Switches with „OFF“

3 phase and 1 phase to neutral						A010-600	3	
						A010-620	3	
						A010-621	3	
						A010-622	3	

Ammeter Switches

Single pole with one current transformer						A046-600	1	
						A046-620	1	
						A046-621	1	
Single pole with 3 current transformers without „OFF“						A017-600	3	
						A017-620	3	
		CL4	CL10			A059-600	3	
		CL4	CL10			A059-620	3	
Single pole with 3 current transformers with „OFF“ 360° rotation						A048-600	3	
						A048-620	3	
						A048-621	3	
		CL4	CA10 CL10			A058-621	3	
						A048-622	3	
		CL4	CL10			A058-622	3	
						A048-623	3	
	CL4	CL10			A058-623	3		

¹available only up to switch type CA25B ²not available for switch types CL4 and CL10

Function	Escutch. Plate	Type/Handle	Code	Stages	Connection Diagram	
		CA4 CA4-1 CL4	CAD.. CA10- CA25 CL10	CA10B- C42	C43- C125	

Ammeter Switches

Single pole with 2 current transformers (3 readings)						A021-600	2	 for CL switches:
						A021-620	2	
Single pole with 4 current transformers						A036-600	4	for A036: for A056:
		CL4	CL10			A056-600	4	
						A036-620	4	
		CL4	CL10			A056-620	4	
2 pole 2 current transformers						A037-600	3	
						A037-620	3	
						A037-621	3	
2 pole 3 current transformers						A019-600	5	
						A019-620	5	
						A038-600	5	
						A038-620	5	
						A038-621	5	
						A038-621	5	
2 pole 4 current transformers						A039-600	6	
						A039-620	6	

¹not available for switch types CL4 and CL10

Switch Function and Configuration

C, CA, CAD, CL Switches

Function	Escutch. Plate	Type/Handle	Code	Stages	Connection Diagram
		CA4 CA4-1 CL4	CAD.. CA10- CA10B- CA25 CL10	C26- C43	

Volt-ammeter Switches

3 phase - phase to phase 3 current						A027-600	6	<p>for A027:</p> <p>for A057:</p>
		CL4	CL10			A057-600		
						A028-600		
3 phase voltage 3 phase current 4 wire						A033-600	5	<p>for CL switches:</p> <p>*19 instead of 11</p>
3 phase voltage 3 phase current 3 wire						A035-600	5	<p>for CL switches:</p> <p>*17 instead of 9</p>

Control Switches

Stop switch						A174-600	1	
Start switch						A175-600	1	
Stop start switch single pole						A176-600	1	
Stop start switch 2 pole						A183-600	2	
Stop start switch with spring return from start to run						A178-600	1	
						A178-620	1	
Stop start switch with spring return to run for 2 units						A177-600	2	
						A177-620	2	

¹not available for switch types CL4 and CL10

Function	Escutch. Plate	Type/Handle	Code	Stages	Connection Diagram	
		CA4 CA4-1 CL4	CAD.. CA10- CA25 CL10	CA10B- CA25B	C26 C32	

Control Switches

Stop start switch with spring return to run with contactor interlock contactors for 2 units						A182-600	2	
						A182-620	2	
Motor voltage control switch						A150-600	2	

Control Switches with electrically isolated contacts

Stop start switch single pole						A789-600	1	
Stop start switch with spring return to 1						A791-600	1	
Stop start switch with spring return to run for 2 units						A790-600	2	
Contactor control with spring return to „OFF“						A179-600	2	
						A179-620	2	
Circuit breaker control						A537-600	2	

Control and Alarm Switches¹

With slip clutch and without indicator device						A190-600	5 ³	
Without indicator device						A192-600	2	

20 ¹Advise the indicator device, described in Catalog 101, page 7. ²not available for switch types CL10, CA25 and CA25B ³incl. slip clutch

Function	Escutch. Plate	Type/Handle				Code	Stages	Connection Diagram
		CA4 CA4-1 CL4	CAD.. CA10- CA25 CL10	CA..B C26- C43	C80- C315			

Motor Reversing Switches

2 pole						A400-600	2	
						A400-620	2	
						A400-621	2	
3 pole						A401-600	3	
						A401-620	3	
						A401-621	3	
3 pole with spring return to „OFF“						A228-600	3	
						A228-620	3	
3 pole for use with reversing contactors						A402-600	4	

Motor Control Switches

2 speed 2 winding 0-A-BY or Δ						A451-600	3	
						A451-620	3	
3 speed 2 winding 0-AΔ-BY-AΥ						A457-600	6	
						A457-620	6	

¹not available for switch type CA25 ²not available for switch types C26 and C32 ³not available for switch types C42 and C43

Function	Escutch. Plate	Type/Handle	Code	Stages	Connection Diagram
		CA4 CA4-1 CL4	CAD.. CA10- CA25 CL10	CA10B- CA25B C26- C315	

Motor Control Switches

2 speed single winding						A440-600	4	
						A440-620	4	
2 speed single winding without „OFF“						A466-600	4	
2 speed single winding with center „OFF“						A441-600	4	
						A441-620	4	
2 speed single winding reversing						A442-600	6	
						A442-620	6	
2 speed single winding for use with contactors						A444-600	5	
						A444-620	5	
2 speed reversing for 2 way operation with slip clutch for „OFF“ load use						A468-600	10 ¹	
						A468-620	10 ¹	

Function	Escutch. Plate	Type/Handle				Code	Stages	Connection Diagram
		CA4 CA4-1 CL4	CAD.. CA10- CA25 CL10	CA..B C26- C43	C80- C315			

Star-delta Switches

OFF-star-delta						A410-600	4	
						A410-620	4	
Reversing						A413-600	5	
With auxiliary contact closed in „OFF“ position						A416-600	5	
For use with reversing contactors						A419-600	4	

Start and Run Switches

Split-phase start						A425-600	2	
						A425-620	2	
Split-phase start reversing						A426-600	3	
						A426-620	3	
Split-phase reversing auto cutout of start field winding						A622-600	3	

¹not available for switch types CL4 and CL10 ²not available for switch type CA25

Function/Type	Escutch. Plate	Handle	Code	Stages	Double Latching	Connection Diagram	L350 L630 L1000 L1250	L351 L631 L1001 L1251
---------------	----------------	--------	------	--------	-----------------	--------------------	--------------------------------	--------------------------------

ON/OFF Switches with 60° Switching

1 pole 2 pole 3 pole 4 pole			A200-600 A201-600 A202-600 A203-600	1 2 3 4				
1 pole 2 pole 3 pole 4 pole			A200-620 A201-620 A202-620 A203-620	1 2 3 4				
1 pole 2 pole 3 pole 4 pole			A200-600 A201-600 A202-600 A203-600	2 2 4 4				1-4 pole
3 pole with lugs suitable for protective cover			A302-600	3				
1 pole 2 pole 3 pole 4 pole			A200-620 A201-620 A202-620 A203-620	2 2 4 4				A302
1 pole 2 pole 3 pole 4 pole			A200-600 A201-600 A202-600 A203-600	3 3 6 6				1-4 pole
1 pole 2 pole 3 pole 4 pole			A200-600 A201-600 A202-600 A203-600	2 4 6 8	● ●			1-4 pole
1 pole 2 pole 3 pole 4 pole			A200-600 A201-600 A202-600 A203-600	2 4 6 8				1-4 pole
1 pole 2 pole 3 pole 4 pole			A200-600 A201-600 A202-600 A203-600	3 6 9 12	● ● ●			1-4 pole
1 pole 2 pole 3 pole			A200-600 A201-600 A202-600	3 6 9				1-3 pole
1 pole 2 pole 3 pole			A200-600 A201-600 A202-600	4 8 12	● ●			1-3 pole
1 pole 2 pole 3 pole			A200-600 A201-600 A202-600	4 8 12				1-3 pole
1 pole 2 pole			A200-600 A201-600	5 10	●			1 and 2 pole

Function/Type	Escutch. Plate	Handle	Code	Stages	Double Latching	Connection Diagram	L350 L630 L1000 L1250	L351 L631 L1001 L1251
---------------	----------------	--------	------	--------	-----------------	--------------------	--------------------------------	--------------------------------

ON/OFF Switches with 90° Switching

1 pole 2 pole 3 pole 4 pole	L350/L351 1 pole preclose 60°			A290-600 A291-600 A292-600 A293-600	1 2 3 4			
1 pole 2 pole 3 pole 4 pole	L400 1 pole preclose 60°			A290-600 A291-600 A292-600 A293-600	2 2 4 4			
3 pole	with lugs suitable for protective cover			A307-600	3			
3 pole	360° rotation			A208-600	4			
1 pole 2 pole 3 pole 4 pole	L600 1 pole preclose 60°			A290-600 A291-600 A292-600 A293-600	3 3 6 6	● ●		
1 pole 2 pole 3 pole 4 pole	L630/L631 1 pole preclose 60°			A290-600 A291-600 A292-600 A293-600	2 4 6 8	● ●		
1 pole 2 pole 3 pole 4 pole	L800 1 pole preclose 60°			A290-600 A291-600 A292-600 A293-600	2 4 6 8	● ● ●		
1 pole 2 pole 3 pole 4 pole	L1000/L1001 1 pole preclose 60°			A290-600 A291-600 A292-600 A293-600	3 6 9 12	● ● ●		
1 pole 2 pole 3 pole	L1200			A290-600 A291-600 A292-600	3 6 9	● ● ●		1-3 pole
1 pole 2 pole 3 pole	L1250/L1251			A290-600 A291-600 A292-600	4 8 12	● ●		1-3 pole

● Additional length for switches size S2 for mounting E/EF = 27 mm
 ● Additional length for switches size S3 for mounting E/EF = 31,5 mm and mounting ER/VE = 20,1 mm

Function/Type	Escutch. Plate	Handle	Code	Stages	Double Latching	Connection Diagram	L350 L630 L1000 L1250	L351 L631 L1001 L1251
---------------	----------------	--------	------	--------	-----------------	--------------------	--------------------------------	--------------------------------

ON/OFF Switches with 90° Switching

1 pole 2 pole 3 pole	L1600			A290-600 A291-600 A292-600	4 8 12	● ● ●		1-3 pole
1 pole 2 pole	L2000			A290-600 A291-600	5 10	● ●		1- and 2 pole

Double-throw Switches without „OFF“ 60° Switching

1 pole 2 pole 3 pole 4 pole	L350/L351			A220-600 A221-600 A222-600 A223-600	2 4 6 8			1-4 pole
1 pole 2 pole 3 pole 4 pole	L400			A220-600 A221-600 A222-600 A223-600	2 4 6 8			1-4 pole
1 pole 2 pole 3 pole 4 pole	L600			A220-600 A221-600 A222-600 A223-600	3 6 9 12	● ●		1-4 pole
1 pole 2 pole 3 pole	L630/L631			A220-600 A221-600 A222-600	4 8 12	●		1-3 pole
1 pole 2 pole 3 pole	L800			A220-600 A221-600 A222-600	4 8 12	●		1-3 pole
1 pole 2 pole	L1000/L1001			A220-600 A221-600	6 12	●		1 and 2 pole
1 pole	L1200			A220-600	6			
1 pole	L1250/L1251			A220-600	8			
1 pole	L1600			A220-600	8			
1 pole	L2000			A220-600	10			

Function/Type	Escutch. Plate	Handle	Code	Stages	Double Latching	Connection Diagram	L350 L630 L1000 L1250	L351 L631 L1001 L1251
---------------	----------------	--------	------	--------	-----------------	--------------------	--------------------------------	--------------------------------

Double-throw Switches with Center „OFF“

1 pole 2 pole 3 pole 4 pole	L350/L351			A210-600 A211-600 A212-600 A213-600	2 4 6 8			1-4 pole
1 pole 2 pole 3 pole 4 pole	L400			A210-600 A211-600 A212-600 A213-600	2 4 6 8			1-4 pole
1 pole 2 pole 3 pole 4 pole	L600			A210-600 A211-600 A212-600 A213-600	3 6 9 12	● ●		1-4 pole
1 pole 2 pole 3 pole	L630/L631			A210-600 A211-600 A212-600	4 8 12	●		1-3 pole
1 pole 2 pole 3 pole	L800			A210-600 A211-600 A212-600	4 8 12	●		1-3 pole
1 pole 2 pole	L1000/L1001			A210-600 A211-600	6 12	●		1 and 2 pole
1 pole	L1200			A210-600	6			
1 pole	L1250/L1251			A210-600	8			
1 pole	L1600			A210-600	8			
1 pole	L2000			A210-600	10			

Multi-step Switches single pole without „OFF“

3 Step	L350/L351			A230-600	4			
3 Step	L400			A230-600	4			
4 Step	L350/L351			A231-600	4			
4 Step	L400			A231-600	4			
5 Step	L350/L351			A232-600	6			





- Additional length for switches size S2 for mounting E/EF = 27 mm
- Additional length for switches size S3 for mounting E/EF = 31,5 mm and mounting ER/VE = 20,1 mm

Function/Type	Escutch. Plate	Handle	Code	Stages	Double Latching	Connection Diagram	L350 L630 L1000 L1250	L351 L631 L1001 L1251
---------------	----------------	--------	------	--------	-----------------	--------------------	--------------------------------	--------------------------------



Multi-step Switches single pole without „OFF“

5 Step	L400			A232-600	6			
6 Step	L350/L351			A233-600	6			
6 Step	L400			A233-600	6			
7 Step	L350/L351			A234-600	8			
7 Step	L400			A234-600	8			
8 Step	L350/L351			A235-600	8			
8 Step	L400			A235-600	8			
9 Step	L350/L351			A236-600	10			
9 Step	L400			A236-600	10			
10 Step	L350/L351			A237-600	10			
10 Step	L400			A237-600	10			
11 Step	L350/L351			A238-600	12			
11 Step	L400			A238-600	12			
12 Step	L350/L351			A239-600	12			
12 Step	L400			A239-600	12			









Two Hole Panel Mounting or Mosaic Mounting	Terminals rotated 90°	Code	CA4 CA4-1 CL4
--	-----------------------	-------------	---------------------

	<p>Panel mounting</p> <p>Two hole panel mounting</p>	●	E E-V	● ●
	<p>Panel mounting with shaft seal Protection IP 65</p> <p>Two hole panel mounting</p>	●	EF EF-V	● ●
	<p>Panel mounting with round shaft for combining with commercial radio knobs</p> <p>Two hole panel mounting Shaft diam. 6 mm/.24 inch</p> <p>Two hole panel mounting Shaft diam. 6.35 mm/.25 inch</p>		E9 E91	● ●
	<p>Mosaic mounting</p> <p>For Siemens-Mosaic 30 mm grid depth</p> <p>For Subklew-, Kreutzenbeck-, Symo-Mosaic 28 mm 25 mm 25 mm grid depth</p> <p>For Mauell-Mosaic 30 mm grid depth</p>		E92 E93 E94	● ● ●





Two or Four Hole Panel Mounting	Terminals rotated 90°	Code	CAD.. CA10- CA25 CL10	CA10B- C42	C43- C125 L350- L1251 Size S2	C315 L400- L2000 Size S3
--	-----------------------	-------------	--------------------------------	---------------	---	-----------------------------------

 <p>Panel mounting</p> <p>Four hole panel mounting</p> <p>Four hole panel mounting Protection IP 65</p> <p>Two hole panel mounting Protection IP 65</p>	<p>●</p> <p>●</p> <p>●</p>	<p>E E-V</p> <p>EF EF-V</p> <p>E22 E22-V</p>	<p>●</p> <p>●</p> <p>●</p>	<p>●</p> <p>●</p> <p>●</p>	<p>●</p> <p>●</p> <p>●</p>	<p>●</p> <p>●</p> <p>●</p>
 <p>Panel mounting using larger escutcheon plate and handle and with heavy duty latching</p> <p>Four hole panel mounting</p> <p>Four hole panel mounting Protection IP 65</p>		<p>EG</p> <p>EGF</p>	<p>●</p> <p>●</p>	<p>C26- C42</p> <p>C26- C42</p>	<p>C80- C125</p> <p>C80- C125</p>	
 <p>Panel and base mounting</p> <p>Four hole mounting</p> <p>Four hole mounting Protection IP 65</p>		<p>ER</p> <p>ERF</p>	<p>●</p> <p>●</p>	<p>●</p> <p>●</p>	<p>●</p> <p>●</p>	<p>●</p> <p>●</p>

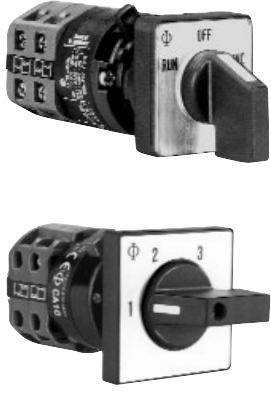

Two or Four Hole Panel Mounting	Code	CAD.. CA10- CA25 CL10	CA10B CA11B CA20B CA25B C26	C32 C42	C43
--	-------------	--------------------------------	---	------------	-----

	<p>Panel mounting with heavy duty latching and metal shaft</p> <p>Four screw panel mounting Mounting plate, escutcheon plate and handle of size S0</p>	KN2	●			
	<p>Four screw panel mounting Mounting plate, escutcheon plate and handle of size S1</p>	KN1	●	●	●	
	<p>Four screw panel mounting Mounting plate, escutcheon plate and handle of size S1 and 6 mm square metal shaft</p>	KD1	●	●	●	
	<p>Panel mounting with protective cover</p>	EC	CAD.. CA10- CA25	●	●	●
	<p>Four screw panel mounting with additional shaft seal Protection front IP 65 rear IP 30 for CA and CAD IP 42 for C26-C43</p>	ED	CAD.. CA10- CA25	●	●	●
	<p>Four screw panel mounting Protection front IP 40 rear IP 42</p>	EC1		●		
	<p>Four screw panel mounting with additional shaft seal Protection front IP 65 rear IP 42</p>	ED1		●		
	<p>Two screw panel mounting Protection front IP 65 rear IP 42</p>	ED22	CAD.. CA10- CA25			





Single Hole Mounting	Terminals rotated 90°	Code	CA4 CA4-1 CL4	CAD.. CA10- CA25 CL10
----------------------	-----------------------	------	---------------------	--------------------------------

			mm	mm
<p>With locking nut and shaft seal, protection IP 65</p> <p>Without escutcheon plate</p> 	●	FS1 FS1-V	16/22 16/22	
<p>With square escutcheon plate</p> 	●	FS2 FS2-V	16/22 16/22	
<p>With rectangular escutcheon plate</p> 	●	FS4 FS4-V	16/22 16/22	
<p>With size S1 escutcheon plate and heavy duty latching</p> 	●	FH3 FH3-V		22 22
<p>Mounting key for locking nut</p> 		S00 T170 09		





<p>Base Mounting</p>	<p>Terminals rotated 90°</p>	<p>Code</p>	<p>CAD.. CA10- CA25 CL10</p>	<p>CA10B- C42</p>	<p>C43- L2000</p>
-----------------------------	------------------------------	--------------------	--	-----------------------	-----------------------

<p>Base mounting</p>					
	<p>Base mounting - four hole</p> <p>For four hole base mounting and with integrated simplified door clutch, protection IP 65</p>	<p>●</p> <p>●</p>	<p>VE VE-V</p> <p>VF VF-V</p>	<p>CAD.. CA10- CA25</p> <p>CAD.. CA10- CA25</p>	<p>●</p> <p>●</p> <p>●</p>
	<p>For two hole base mounting</p> <p>For two hole base mounting and with integrated simplified door clutch, protection IP 65</p>	<p>●</p> <p>●</p>	<p>VE22 VE22V</p> <p>VF22 VF22V</p>	<p>● CAD.. CA10- CA25</p> <p>● CAD.. CA10- CA25</p>	<p></p> <p></p>
	<p>Snap-on base mounting for track EN 50022</p>	<p></p>	<p>VE1</p>	<p>●</p>	<p>●</p>

Base Mounting	Code	CA4 CA4-1	CAD.. CA10- CA25 CL10
---------------	------	--------------	--------------------------------

Base mounting				
	<p>Snap-on base mounting for track EN 50022 with escutcheon plate for 45 mm standard knock-out.</p>	VE2	●	
	<p>Snap-on base mounting for track EN 50022. Both the escutcheon plate for 45 mm standard knock-out and the handle are adjustable in height.</p>	VE21	●	CAD.. CA10- CA25
	<p>Snap-on base mounting for track EN 50022 with circular escutcheon plate for 46 mm knock-out.</p>	VE3	●	
	<p>Base mounting - four hole - for circular escutcheon plate with 46 mm knock-out.</p>	VE4		CAD.. CA10- CA25

<p>Mounting Plates for Plaster Depth Boxes acc. to DIN 49070 and ÖNORM E6508</p>	<p>Code</p>	<p>CAD.. CA10- CA25</p>
--	-------------	---------------------------------

	<p>Plaster depth trim</p>	<p>UE1</p>	<p>●</p>
	<p>With light</p> <p>With facility for light addition</p>	<p>UE2</p> <p>UE3</p>	<p>●</p> <p>●</p>
	<p>Plaster depth trim</p> <p>With light</p> <p>With facility for light addition</p>	<p>UE4</p> <p>UE5</p> <p>UE6</p>	<p>●</p> <p>●</p> <p>●</p>
	<p>For multiple boxes</p>	<p>UE7</p>	<p>●</p>

Escutcheon Plates

60° switching

F7070	F7072	F087	F088	F089	F133	F163	F164	F192	F193	F196	F197	F198	F230	F231	F232	F234	F243
F244	F247	F257	F262	F263	F264	F268	F282	F288	F470	F291	F310	F311	F313	F323	F328	F352	F367
F379	F380	F382	F705	F721	F722	F750	F754	F071	F073	F075	F076	F080	F081	F085	F086	F090	F091
F092	F093	F094	F098	F104	F194	F220	F223	F235	F237	F239	F240	F241	F249	F260	F269	F469	F274
F281	F290	F292	F312	F314	F315	F316	F324	F331	F344	F354	F356	F357	F358	F359	F364	F370	F371
F373	F377	F381	F385	F723	F732	F735	F077	F100	F101	F102	F309	F342	F343	F361	F362	F363	F365
F366	F074	F078	F082	F096	F097	F191	F195	F256	F325	F326	F720	F724	F079	F083	F084	F095	F099
F185	F190	F199	F233	F236	F238	F242	F283	F275	F370	F371	F736	F737					

90° switching

F056	F058	F063	F065	F068	F069	F134	F177	F178	F182	F201	F208	F251	F252	F253	F254	F340	F346
F360	F378	F456	F458	F700	F743	F057	F061	F064	F067	F171	F181	F205	F207	F209	F320	F349	F715
F719	F059	F060	F062	F066	F170	F172	F173	F174	F175	F176	F179	F180	F186	F188	F202	F204	F206
F250	F265	F266	F286	F318	F327	F338	F339	F425	F716	F717	F718	F726	F733	F751	F755	F756	F437







Miscellaneous





F119	F122	F125	F126	F129	F130	F225	F246	F248	F261	F341	F123	F127	F145	F146	F148	F245	F287
F345	F706	F707	F120	F121	F124	F128	F131	F132	F749								
F801	F802	F803	F804	F805	F806	F807	F808	F809	F810	F811	F812	F813	F814	F815	F816	F817	F818
F819	F820	F821	F822	F823	F824	F825	F826	F827	F828	F829	F830	F831	F832	F833	F834	F835	

Handles

















Type	Color	Code	Size
			S00 S0 S1 S2 S3

Type	Color	Code	Size
			S00 S0 S1 S2 S3

R-Handle 	black red white electro-gray	G001 G002 G003 G007	— ● ● ● ● — ● ● ● ● — ● ● ● ● — ● ● ● ●
F-Handle 	black red white electro-gray	G221 G222 G223 G227	● ● ● ● — ● ● ● ● — ● ● ● ● — ● ● ● ● —
S-Handle  S0 S1	black red white electro-gray	G301 G302 G303 G307	— ● ● — — — ● ● — — — ● ● — — — ● ● — —
P-Handle  S0 S1-S3	black red white electro-gray	G211 G212 G213 G217	— ● ● ● ● — ● ● ● ● — ● ● ● ● — ● ● ● ●
Handwheel 	black	G971	— — — — ●
Capstan Handle 	black	G931	— — — — ●

I-Handle  S00 S0-S3	black red white electro-gray	G251 G252 G253 G257	● ● ● ● ● ● ● ● ● ● ● ● ● ● ● ● ● ● ● ●
B-Handle 	black red white electro-gray	G521 G522 G523 G527	— ● ● — — — ● ● — — — ● ● — — — ● ● — —
L-Handle 	black red white electro-gray	G501 G502 G503 G507	— — ● — — — — ● — — — — ● — — — — ● — —
K-Handle 	black red white electro-gray	G411 G412 G413 G417	— — ● ● ● — — ● ● ● — — ● ● ● — — ● ● ●
O-Handle 	black red white electro-gray	G321 G322 G323 G327	— — ● — — — — ● — — — — ● — — — — ● — —

International Standards and Approvals

Country	Authority	Mark or Standard	CAD11/12	CA10	CA10B	C26	C43	L350/1	L1250/1	L400	L1200	
			CA4	CA11	CA11B		CA25	C32	C80	L630/1	C315	L600
			CA4-1	CA20	CA20B	CA25B	C42	C125	L1000/1	C316	L800	L2000
USA	Underwriters Laboratories Inc.	 ¹						●	●	●	●	
		 ²  ³	●	●	●	●	●	●			●	+
Canada	UL investigated acc. to CSA	 ⁶	+	●	●	●	●	●	●	●	●	
		 ¹						●	●	●	●	
		 ²  ³	●	●	●	●	●	●			●	
Switzerland	Schweizerischer Elektrotechnischer Verein		+	+	+	+	+	+	+	+	+	
Denmark	Danmarks Elektriske Materielkontrol		+	+	+	+	+	+	+	+	+	
Norway	Norges Elektriske Materielkontrol		+	+	+	+	+	+	+	+	+	
Sweden	Svenska Elektriska Materielkontrollanstalten		+	+	+	+	+	+	+	+	+	
Finland	Sähkötar-kastuskeskus		+	+	+	+	+	+	+	+	+	
Austria	Österreichischer Verband für Elektrotechnik		+	+	+	+	+	+	+	+	+	
Federal Republic of Germany	Verband Deutscher Elektrotechniker	VDE 0660 ⁴	+	+	+	+	+	+	+	+	+	
Great Britain	British Standards Institution	BS EN 60947 ⁴	+	+	+	+	+	+	+	+	+	
International Electrical Commission (IEC) Recommendation		IEC 60947 ⁵	+	+	+	+	+	+	+	+	+	
China	China Quality Certification Centre	 ⁷ GB14048.3	●	●	●							
Russian Federation	GOST	 ⁷ CH01	●	●	●	●	●	+	+	+	+	
Germanischer Lloyd			+	+	+	+	+	+	+	+	+	
Lloyds Register of Shipping			+	+	+	+	+	+	+	+	+	

● Switch approved + Switch conforms to requirements + No approval required

¹Approved under the "Component Program" (UL-Recognized Industrial Component). File No. E35541, Category Control No. NLRV2 (U.S.) resp. NLRV8 (Canada).
²Approved under the "Listing Program". File No. E35541, Category Control No. NLRV (U.S.) resp. NLRV7 (Canada).
³Switch types CAD11/CAD12 approved under the "Listing Program". File No. E60262, Category Control No. NRNT (U.S.) resp. NRNT7 (Canada).
⁴It is not required for Industrial Switchgear to bear a symbol but must conform to requirements. By stating the specific standard no. on the product the manufacturer declares that all requirements of the product standard are met.
⁵IEC does not operate an approval scheme.
⁶File No. 13002, Class No. 3211-05 resp. 4652-04.
⁷If this approval is required, please request when ordering.

Selection Data	CA4	CA10	CA11	CA20	CA25	C42							
	CA4-1 CL4	CA10B CL10	CA11B CA20B	CA25B C26	C32	C43	C80	C125	C315/C316				

Rated Insulation Voltage U_i	IEC 60947-3, EN 60947-3 ¹	V	440	440	690	690	690	690	690	690	690	690	690	690	690/1000							
	VDE 0660 part 107 ¹	V	380	380	660	690	660	660	690	660	660	660	660	660	660							
	SEV ⁴	V	300	-	300	-	600	600	300	600	600	600	600	600	600							
	UL/Canada CEE/NEMKO	V	400/380	-	380	-	400	400	-	400	400	400	400	-	-							
Rated Impulse Withstand Voltage U_{imp}		kV	4	4	6	6	6	6	6	6	6	6	6	6/8								
Rated Thermal Current I_U/I_{th}	IEC 60947-3, EN 60947-3	A	10	10	20	20	20	25	32	32	50	63	115	150	315							
	VDE 0660 part 107	A	10	10	16	16	16	25	32	32	40	63	100	160	315							
	SEV ⁴	A	-	-	12	12	12	25	32	32	40	63	-	-	315							
	UL/Canada	A	10	-	20	-	20	30	30	40	50	65	100	150	240							
Rated Operational Current I_e	AC-21A Switching of resistive loads, including moderate overloads	IEC 60947-3, EN 60947-3	A	10	10	20	20	20	25	32	32	40	63	100	150	315						
	VDE 0660 part 107	A	10	10	16	16	16	25	32	32	40	63	100	160	315							
	AC-1 Resistive or low inductive loads	SEV ⁴	A	-	-	12	12	12	20	32	32	40	63	-	-	315						
	660 V	A	10	-	20	-	20	30	30	40	50	65	100	150	240							
	AC-22A Switching of combined resistive or low inductive loads including moderate overloads	IEC 60947-3, EN 60947-3	A	10	10	20	20	20	25	32	32	40	63	100	150	315						
	VDE 0660 part 107	A	-	-	20	20	20	25	32	32	40	63	100	125	125							
	AC-15 Switching of control devices, contactors, valves etc.	IEC 60947-3, EN 60947-3	A	2,5	2,5	5	5	5	8	12	14	16	-	-	-	-						
	VDE 0660 part 107	A	1,5	1,5	4	4	4	5	6	6	7	-	-	-	-							
	220 V-240 V	VAC	300	-	300	-	600	600	300	600	600	600	-	-	-	-						
	380 V-440 V	A	10	-	20	-	20	30	30	40	50	65	100	150	240							
Pilot Duty	UL/Canada ⁴	Heavy	A	10	-	20	-	20	30	40	50	65	100	150	240							
Ampere Rating	UL/Canada ⁴		A	10	-	20	-	20	30	40	50	65	100	150	240							
Resistive or low inductive loads			A	10	-	20	-	20	30	40	50	65	100	150	240							
Resistive load/motor load	CEE		A	4/2	-	10/6	-	10/6	16/10	-	25/10	32/10	40/10	63/10	-							
NEMKO		A	6/4 ²	-	10/6	-	-	20/10	-	-	-	-	-	-	-							
Short Circuit Protection	Max. fuse size (gL-characteristic)	A	10	10	25	25	25	35	35	50	63	80	125	200	315							
	Rated short-time withstand current (1s-current)	A	60	90	140	140	140	280	480	350	800	1000	1300	2000	4200							
DC Switching Capacity	No. of series contacts	1	2	3	4	5	6	8	Rated Operational Current I_e													
		Voltage V								CA4	CA10	CA11	CA20	CA25	C315 ³							
	Resistive loads	24	48	70	95	120	145	190	A	10	10	20	20	20	25	32	-	50	-	115	-	315
		48	95	140	190	240	290	350	A	6	6	12	12	12	20	25	32	40	63	100	150	250
		60	120	180	240	300	360	450	A	2,5	2,5	4,5	4,5	4,5	7,5	10	23	27	30	-	-	-
		110	220	330	440	550	660	-	A	0,7	0,7	1	1	1	1,5	2	6,5	-	-	-	-	-
		220	440	660	-	-	-	-	A	0,3	0,3	0,4	0,4	0,4	0,5	0,6	1,2	-	-	-	-	-
	440	660	-	-	-	-	-	A	0,2	0,2	0,27	0,27	0,27	0,3	0,3	0,4	-	-	-	-	-	
	Inductive loads	24	48	70	95	120	145	190	A	6	6	12	12	12	20	25	32	40	63	100	150	250
		30	60	90	120	150	180	240	A	3	3	5	5	5	9	12	25	30	55	33	50	70
48		95	140	190	240	290	350	A	1	1	2	2	2	3	3	16	20	-	-	-	-	
60		120	180	240	300	360	450	A	0,7	0,7	1	1	1	1,5	1,5	11	15	-	-	-	-	
110		220	330	440	550	660	-	A	0,3	0,3	0,4	0,4	0,4	0,5	0,5	3,2	3,5	-	-	-	-	
Ambient Temperature of Stages⁵	open at 100 % I_U/I_{th}		55 °C during 24 hours with peaks up to 60 °C																			
	enclosed at 100 % I_{the}		35 °C during 24 hours with peaks up to 40 °C																			

¹Valid for lines with grounded common neutral termination, overvoltage category III, pollution degree 3. Values for other supply systems on request. ²Valid for CA4 only. ³DC switching capacity applies to ON/OFF switches. Switching capacity for other configurations on request. ⁴International Standards and Approvals, refer to page 39. ⁵For electromagnetic optional extras see additional data in Catalog 101.

Selection Data	CA4	CA10	CA11	CA20	CA25		C42		C315
	CA4-1 CL4	CA10B CL10	CA11B CA20B	CA25B C26	C32	C43	C80	C125	C316

Rated Utilization Category		IEC 60947-3, EN 60947-3 VDE 0660 part 107																	
AC-2	Slip ring motor starting, reversing and plugging, star-delta starting CA4-C32	3 phase	220 V-240 V	kW	2,5	2,5	4	4	4	5,5	7,5	8	10	18,5	30	37	55		
		3 pole	380 V-440 V		4,5	4,5	7,5	7,5	7,5	11	15	15	18,5	22	40	55	75	90	
			500 V		-	-	10	10	10	15	18,5	18,5	22	40	55	75	110		
			660 V-690 V		-	-	10	10	10	13	15	15	22	37	55	55	55		
AC-3	Direct-on-line starting, star-delta starting C42-C315	3 phase	220 V-240 V	kW	1,5	1,5	3	3	3	4	5,5	5,5	7,5	11	15	22	37		
		3 pole	380 V-440 V		2,2	2,2	5,5	5,5	5,5	7,5	11	11	15	18,5	30	37	55		
			500 V		-	-	5,5	5,5	5,5	7,5	11	11	15	18,5	30	37	55		
			660 V-690 V		-	-	5,5	5,5	5,5	7,5	11	11	15	18,5	30	37	37		
AC-4	Direct-on-line starting, reversing, plugging and inching	1 phase	110 V	kW	0,3	0,3	0,6	0,6	0,6	1,5	2,2	2,2	2,5	3	3,7	5,5	11		
		2 pole	220 V-240 V		0,55	0,55	2,2	2,2	2,2	3	4	4	5,5	6	7,5	11	22		
			380 V-440 V		0,75	0,75	3	3	3	3,7	5,5	5,5	7,5	11	13	18,5	30		
AC-23A	Frequent switching of motors or other high inductive loads	3 phase	220 V-240 V	kW	0,37	0,37	0,55	0,55	0,55	1,5	2,5	2,7	3,7	5,5	6	10	15		
		3 pole	380 V-440 V		0,55	0,55	1,5	1,5	1,5	3	5,5	5,5	6	7,5	11	15	25		
			500 V		-	-	1,5	1,5	1,5	3	5,5	5,5	6	7,5	11	15	25		
			660 V-690 V		-	-	1,5	1,5	1,5	3	5,5	5,5	6	7,5	11	15	22		
AC-23A	Frequent switching of motors or other high inductive loads	1 phase	110 V	kW	0,15	0,15	0,3	0,3	0,3	0,45	0,75	0,75	1,1	1,2	1,5	2,2	4		
		2 pole	220 V-240 V		0,25	0,25	0,75	0,75	0,75	1,1	1,5	1,5	2,2	2,4	3	4	7,5		
			380 V-440 V		0,5	0,5	1,5	1,5	1,5	2,2	3	3	3,7	4	5,5	7,5	11		
AC-23A	Frequent switching of motors or other high inductive loads	3 phase	220 V-240 V	kW	1,8	1,8	3,7	3,7	3,7	5,5	7,5	7,5	11	15	30	37	75		
		3 pole	380 V-440 V		3	3	7,5	7,5	7,5	11	15	15	22	30	45	75	132		
			500 V		-	-	7,5	7,5	7,5	11	15	15	30	45	55	90	132		
			660 V-690 V		-	-	7,5	7,5	7,5	11	15	15	22	55	65	65	37		
AC-23A	Frequent switching of motors or other high inductive loads	1 phase	110 V	kW	0,37	0,37	0,75	0,75	0,75	1,5	2,2	2,2	2,5	4	5,5	11	18,5		
		2 pole	220 V-240 V		0,75	0,75	2,5	2,5	2,5	3	4	4	5,5	10	15	22	37		
			380 V-440 V		1,1	1,1	3,7	3,7	3,7	5,5	7,5	7,5	11	18,5	22	37	55		
Ratings	UL/Canada	Standard motor load DOL-Rating (similar AC-3)	120 V	HP	0,75	-	1,5	-	1,5	3	5	5	7,5	7,5	10	15	30		
			3 phase		240 V	1	-	3	-	3	7,5	10	10	15	15	20	25	75	
			3 pole		480 V	-	-	-	-	5	10	-	20	25	25	30	40	75	
					600 V	-	-	-	-	5	10	-	25	30	30	40	50	60	
		Standard motor load Reversing-Rating (similar AC-4)	120 V	HP	0,33	-	0,5	-	0,5	1,5	2	2	3	3	5	7,5	15		
			1 phase		240 V	0,75	-	1	-	1	3	5	5	7,5	7,5	10	15	40	
			2 pole		277 V	0,75	-	2	-	2	3	5	5	7,5	7,5	10	15	40	
					480 V	-	-	-	-	2	5	-	10	15	15	20	25	50	
		Standard motor load Reversing-Rating (similar AC-4)	600 V	HP	-	-	-	-	2	5	-	15	20	20	25	30	50		
			120 V		HP	-	-	0,5	-	0,5	1	2	2	3	5	7,5	10	15	
			3 phase			240 V	-	-	1	-	1	2	3	3	5	7,5	15	20	30
			3 pole			440 V-600 V	-	-	-	-	3	5	-	10	15	20	25	30	40
Standard motor load Reversing-Rating (similar AC-4)	120 V	HP	-	-	0,17	-	0,17	0,33	1,5	1,5	1,5	2	3	5	7,5				
	1 phase		240 V	-	-	0,5	-	0,5	0,75	3	3	3	5	7,5	10	15			
	2 pole		277 V	-	-	0,6	-	0,6	1	3	3	3	5	7,5	10	15			
Max. Permissible Wire Gage - Use copper wire only Single-core or stranded wire		mm ²	2x	1x ²	2x	1x ²	2x	2x	2x	2x	2x	2x	2x	2x	2x	2x	2x		
			1,5	0,5-1,5	2,5	0,5-2,5	2,5	4	6	6	10	16	35	70	185 ¹				
			AWG	14	-	12	-	12	10	8	8	8	6	2	2/0	MCM			
																350			
Max. Permissible Wire Gage - Use copper wire only Flexible wire (sleeving in accordance with DIN 46228) Flexible AWG wires (without sleeve)		mm ²	2x	1x ²	2x	1x ²	2x	2x	2x	2x	2x	2x	2x	2x	2x	2x	2x		
			1,5	0,5-1,5	2,5	0,5-2,5	2,5	4	4	6	6	10	25	50	150 ¹				
			AWG	(-)	(-)	(2,5)	(-)	(2,5)	(2,5)	(4)	(4)	(6)	(10)	(25)	(50)				
																MCM			

¹Cable lug must accept M12 screw. ²The insulation material of the conductor has to be PVC (typical wire codes are H05V-K0,5 ... H07V-K1,5 or H05V-U0,5 ... H07V-U1,5 etc.). Other materials on request. Connected conductors, which have to be disconnected and re-connected again must be cut in order to ensure a proper electrical connection and to prevent a complete cut-off of the wire insulation. The permissible ambient temperature range when connecting the wires is 5-40 °C.

Selection Data	L350	L630			L1000		L1250		
	L351 L400 L600	L631 L800	L1001 L1200	L1251 L1600	L2000				

Rated Insulation Voltage U_i	IEC 60947-3, EN 60947-3 ¹ VDE 0660 part 107 ¹ UL/Canada ²		V	690	690	690	690	690	690	690	690	690	690	690	
	V	600	600	600	600	600	600	600	600	600	600	600	600	600	
Rated Impulse Withstand Voltage U_{imp}			kV	6	6	6	6	6	6	6	6	6	6	6	
Rated Thermal Current I_U/I_{th}	IEC 60947-3, EN 60947-3 VDE 0660 part 107														
	Ambient temp. +35 °C during 24 hours with peaks up to +40 °C		A	350	500	800	630	1100	1000	1450	1250	1900	2400		
	Ambient temp. +55 °C during 24 hours with peaks up to +60 °C		A	350	500	750	600	950	920	1300	1100	1700	2000		
	UL/Canada ²		A	350	400	630	630	800	1000	1200	1250	1600	2000		
Rated Operational Current I_e	AC-20A No-load operation		IEC 60947-3, EN 60947-3 VDE 0660 part 107	690 V	A	350	500	800	630	1100	1000	1450	1250	1900	2400
	Occasional switching under load $\cos \varphi$ 0,8 (AC-20B)		3 phase, 3 pole and	220 V-440 V 500 V	A	350	500	800	500	1000	630	1200	630	1200	1200
			1 phase, 2 pole	660 V-690 V	A	350	450	500	450	630	500	800	500	800	800
					A	315	350	400	360	400	400	400	400	400	400
	AC-21B Switching of resistive loads, including moderate overloads		3 phase, 3 pole and	220 V-440 V 500 V	A	250	450	500	350	630	400	800	400	800	800
			1 phase, 2 pole	660 V-690 V	A	250	400	450	315	500	350	630	350	630	630
					A	200	300	350	250	350	300	350	300	350	350
	Interrupting Rating		UL/Canada ²	600 V	A	200	300	300	200	300	200	300	200	200	200
			CSA	600 V	A	200	200	200	200	200	200	200	200	200	200
	Rated Utilization Category	IEC 60947-3, EN 60947-3 VDE 0660 part 107													
AC-23B Occasional switching of motors or other high inductive loads		3 phase	220 V-240 V	kW	45	75	75	45	75	45	75	45	75	75	
		3 pole	380 V-440 V	kW	90	132	132	90	132	90	132	90	132	132	
			500 V	kW	110	132	132	110	132	110	132	110	132	132	
			660 V-690 V	kW	65	65	65	65	65	65	65	65	65	65	
Short Circuit Protection	Max. fuse size		(aR-characteristic)	A	400	500	800	630	1250	1000	2x800	1250	2x1000	2x1250	
	Rated short-time withstand current		(1s-current)	A	on request										
Terminals	for connection screw				M12	M12	M16	M16	M16	M16	M16	M16	M16	2xM16	4xM16
	length		mm		20	30	40	30	40	40	40	40	50	50	50
	Cable lug or copper bus														
Ambient Temperature of Stages³	55 °C during 24 hours with peaks up to 60 °C, permissible load see Rated Thermal Current.														

¹Valid for lines with grounded common neutral termination, overvoltage category III, pollution degree 3. Values for other supply systems on request.
²International Standards and Approvals, refer to page 39. ³For electromagnetic optional extras see additional data in Catalog 101.

Two or Four Hole Panel Mounting

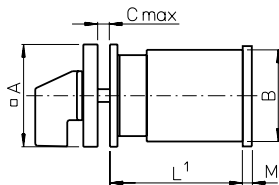

E
for CA4, CA4-1
E-V
for CL4

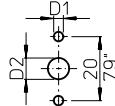

E-V
for CA4, CA4-1
E
for CL4

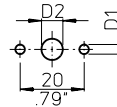

E
E-V
ER

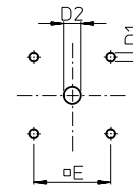

	CA4		CA10 CA11 CAD11		CA10B CA11B							C315				
	CA4-1	CL4	CAD12	CL10	CA20	CA25 ³	CA20B	CA25B	C26	C32	C42 ³	C43	C80	C125	L switches Size S2	L switches Size S3
A	30 1.18	30 1.18	48 1.89	48 1.89	48 1.89	48 (64) 1.89 (2.52)	64 2.52	64 2.52	64 2.52	64 2.52	64 (88) 2.52 (3.46)	88 3.46	88 3.46	88 3.46	88 3.46	130 5.12
B	29.5 1.16	35x46 1.38x1.81	43 1.69	50x56 1.97x2.20	45 1.77	46 1.81	56 2.20	56 2.20	58 2.28	60 2.36	66 2.60	84 3.30	84 3.30	88 3.46	88 3.46	126 4.96
C	4 .16	4 .16	4 .16	4 .16	4 .16	4 .16	4 .16	4 .16	4 .16	4 .16	4 .16	5.5 .22	5.5 .22	5.5 .22	5.5 .22	7 .28
D1	3.2 .13	3.2 .13	5 .20	5 .20	5 .20	5 .20	5 .20	5 .20	5 .20	5 .20	5 (6) .20 (.24)	6 .24	6 .24	6 .24	6 .24	7 .28
D2	8-11 .31-.43	8-11 .31-.43	8-15 .31-.59	8-15 .31-.59	8-15 .31-.59	8-15 .31-.59	10-15 .39-.59	10-15 .39-.59	10-15 .39-.59	10-15 .39-.59	10-15 .39-.59	13-17 .51-.67	13-17 .51-.67	13-17 .51-.67	13-17 .51-.67	15.5-20 .61-.79
E	-	-	36 1.42	36 1.42	36 1.42	36 (48) 1.42 (1.89)	48 1.89	48 1.89	48 1.89	48 1.89	48 (68) 1.89 (2.68)	68 2.68	68 2.68	68 2.68	68 2.68	104 4.09
M²	-	-	4.5 .18	-	4.5 .18	5.5 .22	5 .20	5.5 .22	7.5 .30	7.5 .30	7.5 .30	7.5 .30	9.4 .37	9.4 .37	27.5 1.08	11.9 .47

²M, additional length for mounting ER only
³Dimensions in () for ER mounting plate only

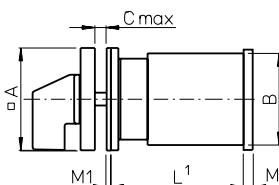

EF
for CA4, CA4-1
EF-V
for CL4

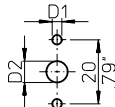

EF-V
for CA4, CA4-1
EF
for CL4

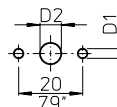

EF
EF-V
ERF

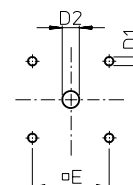

	CA4		CA10 CA11 CAD11		CA10B CA11B							C315				
	CA4-1	CL4	CAD12	CL10	CA20	CA25 ³	CA20B	CA25B	C26	C32	C42 ³	C43	C80	C125	L switches Size S2	L switches Size S3
A	30 1.18	30 1.18	48 1.89	48 1.89	48 1.89	48 (64) 1.89 (2.52)	64 2.52	64 2.52	64 2.52	64 2.52	64 (88) 2.52 (3.46)	88 3.46	88 3.46	88 3.46	88 3.46	130 5.12
B	29.5 1.16	35x46 1.38x1.81	43 1.69	50x56 1.97x2.20	45 1.77	46 1.81	56 2.20	56 2.20	58 2.28	60 2.36	66 2.60	84 3.30	84 3.30	88 3.46	88 3.46	126 4.96
C	4 .16	4 .16	4 .16	4 .16	4 .16	4 .16	4 .16	4 .16	4 .16	4 .16	4 .16	5.5 .22	5.5 .22	5.5 .22	5.5 .22	7 .28
D1	3.2 .13	3.2 .13	5 .20	5 .20	5 .20	5 .20	5 .20	5 .20	5 .20	5 .20	5 (6) .20 (.24)	6 .24	6 .24	6 .24	6 .24	7 .28
D2	8-11 .31-.43	8-11 .31-.43	15-19 .59-.75	15-19 .59-.75	15-19 .59-.75	15-19 .59-.75	19-22 .75-.87	19-22 .75-.87	19-22 .75-.87	19-22 .75-.87	19-22 .75-.87	26-30 1.02-1.18	26-30 1.02-1.18	26-30 1.02-1.18	26-30 1.02-1.18	22-25 .87-.98
E	-	-	36 1.42	36 1.42	36 1.42	36 (48) 1.42 (1.89)	48 1.89	48 1.89	48 1.89	48 1.89	48 (68) 1.89 (2.68)	68 2.68	68 2.68	68 2.68	68 2.68	104 4.09
M²	-	-	4.5 .18	-	4.5 .18	5.5 .22	5 .20	5.5 .22	7.5 .30	7.5 .30	7.5 .30	7.5 .30	9.4 .37	9.4 .37	27.5 1.08	11.9 .47
M1	1 .04	1 .04	-	-	-	-	-	-	-	-	-	-	-	-	-	-

²M, additional length for mounting ERF only
³Dimensions in () for ERF mounting plate only

Two or Four Hole Panel Mounting

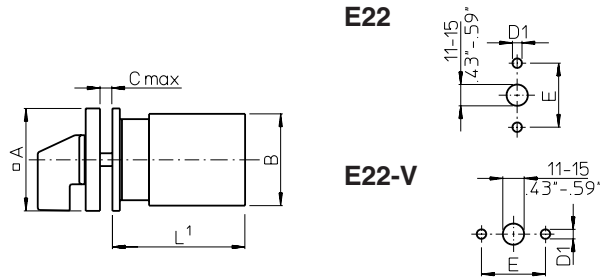

	CA10	CA11	CAD11	CL10	CA20	CA25
A	48 1.89	48 1.89	48 1.89	48 1.89	48 1.89	48 1.89
B	43 1.69	50x56 1.97x2.20	45 1.77	46 1.81	45 1.77	46 1.81
C	4 .16	4 .16	4 .16	4 .16	4 .16	4 .16
D1	5 .20	5 .20	5 .20	5 .20	5 .20	5 .20
E	30 1.17	30 1.17	30 1.17	30 1.17	30 1.17	30 1.17

**EG
EGF**

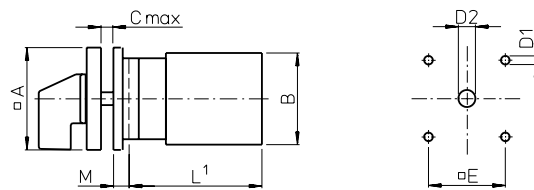

	CA10	CA11	CAD11	CL10	CA20	CA25	C26	C32	C42	C80	C125
											L switches Size S2
A	64 2.52	64 2.52	64 2.52	64 2.52	64 2.52	64 2.52	88 3.46	88 3.46	88 3.46	130 5.12	130 5.12
B	43 1.69	50x56 1.97x2.20	45 1.77	46 1.81	45 1.77	46 1.81	58 2.28	60 2.36	66 2.60	84 3.30	88 3.46
C	4 .16	4 .16	4 .16	4 .16	4 .16	4 .16	5.5 .22	5.5 .22	5.5 .22	7 .28	7 .28
D1	5 .20	5 .20	5 .20	5 .20	5 .20	5 .20	6 .24	6 .24	6 .24	7 .28	7 .28
EG D2	10-15 .39-.59	10-15 .39-.59	10-15 .39-.59	10-15 .39-.59	10-15 .39-.59	10-15 .39-.59	13-17 .51-.67	13-17 .51-.67	13-17 .51-.67	15.5-20 .61-.79	15.5-20 .61-.79
EGF D2	19-22 .75-.87	19-22 .75-.87	19-22 .75-.87	19-22 .75-.87	19-22 .75-.87	19-22 .75-.87	26-30 1.02-1.18	26-30 1.02-1.18	26-30 1.02-1.18	22-25 .87-.98	22-25 .87-.98
E	48 1.89	48 1.89	48 1.89	48 1.89	48 1.89	48 1.89	68 2.68	68 2.68	68 2.68	104 4.09	104 4.09
EG M	6.7 .26	6.7 .26	6.7 .26	6.7 .26	6.7 .26	6.7 .26	0.5 .02	0.5 .02	0.5 .02	2 .08	2 .08
EGF M	6.7 .26	6.7 .26	6.7 .26	6.7 .26	6.7 .26	6.7 .26	0.5 .02	0.5 .02	0.5 .02	2 .08	2 .08

¹see page 51

Four Hole Panel Mounting or Mosaic Mounting

E9
E91

E92

E93
E94

CA4		CL4	
B	29,5	35x46	
	1.16	1.38x1.81	

CA4		CA4-1				
CL4		E9	E91	E92	E93	E94
D	6	6,35	-	-	-	-
F	.24	.25	-	-	-	-
G	12	12,8	-	-	-	-
K	.47	.50	-	-	-	-
M	15,4	17,4	32,5	28,5	32,5	
	.61	.69	1,28	1,12	1,28	
	4,7	5,5	-	-	-	
	.19	.22	-	-	-	
	-	-	-	4	-	
				.16	-	

KN1
KD1
KN2

	CA10				CA10B				
	CAD12	CL10	CA20	CA25	CA20B	CA25B	C26	C32	C42
A	48	48	48	48	64	64	64	64	64
	1.89	1.89	1.89	1.89	2.52	2.52	2.52	2.52	2.52
B	43	50x56	45	46	56	56	58	60	66
	1.69	1.97x2.20	1.77	1.81	2.20	2.20	2.28	2.36	2.60
C	4	4	4	4	4	4	4	4	4
	.16	.16	.16	.16	.16	.16	.16	.16	.16
D1	5	5	5	5	5	5	5	5	5
	.20	.20	.20	.20	.20	.20	.20	.20	.20
D2	8-15	8-15	8-15	8-15	10-15	10-15	10-15	10-15	10-15
	.31-.59	.31-.59	.31-.59	.31-.59	.39-.59	.39-.59	.39-.59	.39-.59	.39-.59
E	36	36	36	36	48	48	48	48	48
	1.42	1.42	1.42	1.42	1.89	1.89	1.89	1.89	1.89
M	5,2	5,2	5,2	5,2	7	7	7	7	7
	.20	.20	.20	.20	.28	.28	.28	.28	.28

	CA11				CA11B				
	CAD12	CL10	CA20	CA25	CA20B	CA25B	C26	C32	C42
A	64	64	64	64	64	64	64	64	64
	2.52	2.52	2.52	2.52	2.52	2.52	2.52	2.52	2.52
B	43	50x56	45	46	56	56	58	60	66
	1.69	1.97x2.20	1.77	1.81	2.20	2.20	2.28	2.36	2.60
C	4	4	4	4	4	4	4	4	4
	.16	.16	.16	.16	.16	.16	.16	.16	.16
D1	5	5	5	5	5	5	5	5	5
	.20	.20	.20	.20	.20	.20	.20	.20	.20
D2	10-15	10-15	10-15	10-15	10-15	10-15	10-15	10-15	10-15
	.39-.59	.39-.59	.39-.59	.39-.59	.39-.59	.39-.59	.39-.59	.39-.59	.39-.59
E	48	48	48	48	48	48	48	48	48
	1.89	1.89	1.89	1.89	1.89	1.89	1.89	1.89	1.89
M	4,7	4,7	4,7	4,7	7	7	7	7	7
	.19	.19	.19	.19	.28	.28	.28	.28	.28

Single Hole Mounting or Base Mounting

FS1...
FT1...
FT3...

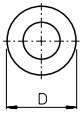

FH3...
FS2...
FT2...
FT4...



FS4...

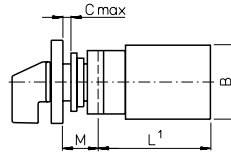
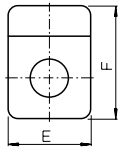

FS1...
FS2...
FS4...

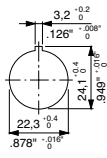
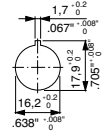

FH3...
FT1...
FT2...

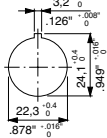

FT3...
FT4...

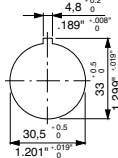
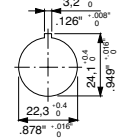

A/E

FH3...

B

C

D

F

M

FH3...

	CA4	CL4	CA10 CA11 CAD11 CAD12	CL10	CA20	CA25
A/E	30 1.18	30 1.18	48 1.89	48 1.89	48 1.89	48 1.89
FH3...	-	-	64 2.52	64 2.52	64 2.52	64 2.52
B	28 1.10	35x46 1.38x1.81	43 1.69	50x56 1.97x2.20	45 1.77	46 1.81
C	5	5	6	6	6	6
D	.20	.20	.24	.24	.24	.24
F	29.5 1.16	29.5 1.16	39 1.54	39 1.54	39 1.54	39 1.54
M	39 1.54	39 1.54	-	-	-	-
FH3...	12.5 .49	12.5 .49	18.2 .72	18.2 .72	18.2 .72	18.2 .72
FH3...	-	-	25.2 .99	25.2 .99	25.2 .99	25.2 .99

VE
VE-V

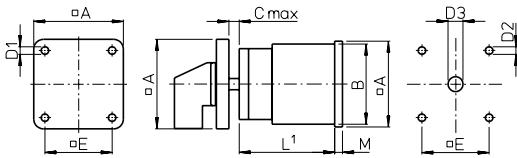

VE22
VE22V

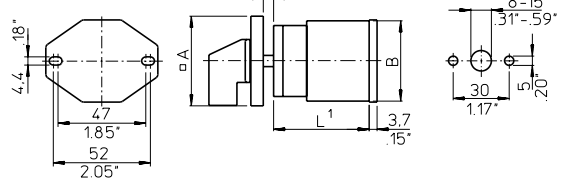

VF
VF-V

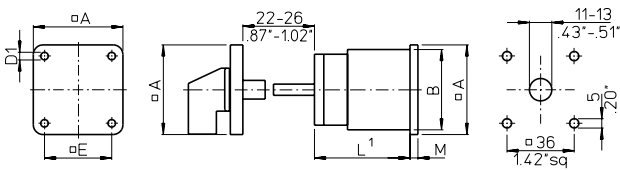

VF22
VF22V

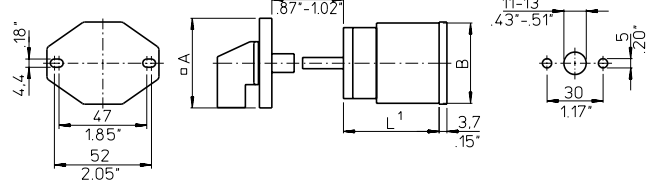

	CA10	CA11	CAD11	CA10B CA11B CA20B	CA25B	C26	C32	C42 ²	C43	C80	C125	L switches Size S2	L switches Size S3
A	48 1.89	48 1.89	48 1.89	48 (64) 1.89 (2.52)	64 2.52	64 2.52	64 2.52	64 (88) 2.52 (3.46)	88 3.46	88 3.46	88 3.46	88 3.46	128 5.04
B	43 1.69	50x56 1.97x2.20	45 1.77	46 1.81	56 2.20	56 2.20	58 2.28	60 2.36	66 2.60	84 3.30	84 3.30	88 3.46	88 3.46
C	10.5 .41	10.5 .41	10.5 .41	10.5 .41	13.5 .53	13.5 .53	13.5 .53	13.5 .53	13.5 .53	16 .63	16 .63	16 .63	19.3 .76
D1	4.1 .16	-	4.1 .16	4.1 .16	4.1 .16	4.1 .16	4.1 .16	5.4 .21	5.4 .21	5.4 .21	5.4 .21	5.4 .21	7 .28
D2	5 .20	-	5 .20	5 .20	5 .20	5 .20	5 .20	5 .20	6 .24	6 .24	6 .24	6 .24	7 .28
D3	8-15 .31-.59	-	8-15 .31-.59	8-15 .31-.59	10-15 .39-.59	10-15 .39-.59	10-15 .39-.59	10-15 .39-.59	10-15 .39-.59	13-17 .51-.67	13-17 .51-.67	13-17 .51-.67	15.5-20 .61-.79
E	36 1.42	-	36 1.42	36 (48) 1.42 (1.89)	48 1.89	48 1.89	48 1.89	48 (68) 1.89 (2.68)	68 2.68	68 2.68	68 2.68	68 2.68	104 4.09
M	2.2 .09	-	2.2 .09	3.2 .13	2.5 .10	2.5 .10	5 .20	5 .20	5 .20	7 .28	8.9 .35	8.9 .35	11.4 .45

²Dimensions in () for revertive mounting plate

Base Mounting

VE1

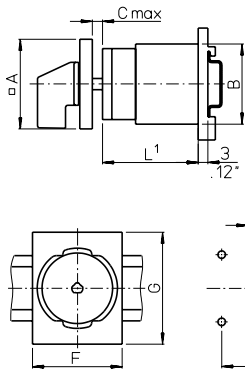

	CA10	CA11	CAD11	CL10	CA20	CA25	CA10B	CA11B	CA20B	CA25B	C26	C32	C42
A	48	48	48	48	48	48	64	64	64	64	64	64	64
	1.89	1.89	1.89	1.89	1.89	1.89	2.52	2.52	2.52	2.52	2.52	2.52	2.52
B	43	50x56	45	46	56	56	60	66	60	66	60	66	66
	1.69	1.97x2.20	1.77	1.81	2.20	2.20	2.28	2.36	2.20	2.28	2.28	2.36	2.60
C	10,5	10,5	10,5	10,5	13,5	13,5	13,5	13,5	13,5	13,5	13,5	13,5	13,5
	.41	.41	.41	.41	.53	.53	.53	.53	.53	.53	.53	.53	.53
D1	5	5	5	5	5	5	5	5	5	5	5	5	5
	.20	.20	.20	.20	.20	.20	.20	.20	.20	.20	.20	.20	.20
D2	8-15	8-15	8-15	8-15	10-15	10-15	10-15	10-15	10-15	10-15	10-15	10-15	10-15
	.31-.59	.31-.59	.31-.59	.31-.59	.39-.59	.39-.59	.39-.59	.39-.59	.39-.59	.39-.59	.39-.59	.39-.59	.39-.59
E	36	36	36	36	48	48	48	48	48	48	48	48	48
	1.42	1.42	1.42	1.42	1.89	1.89	1.89	1.89	1.89	1.89	1.89	1.89	1.89
F	48	48	48	48	70	70	70	70	70	70	70	70	70
	1.89	1.89	1.89	1.89	2.76	2.76	2.76	2.76	2.76	2.76	2.76	2.76	2.76
G	60	60	60	60	60	60	60	60	60	60	60	60	60
	2.36	2.36	2.36	2.36	2.36	2.36	2.36	2.36	2.36	2.36	2.36	2.36	2.36

VE2

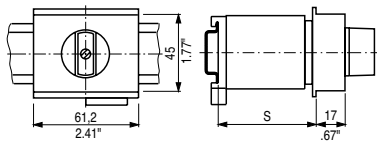

VE21 (for CA4 and CA4-1)

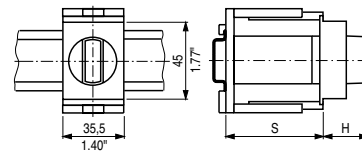

VE3

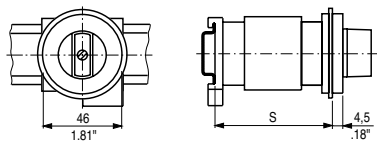

VE21 (for CA10-CA25)

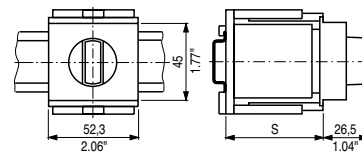

VE4

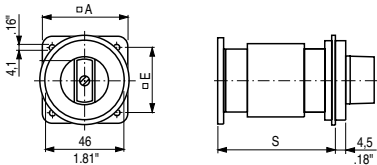

	VE2			VE3		VE4			VE21						
	CA10 CAD11 CAD12	CA11 CA20 CL10	CA25	CA10 CAD11 CAD12	CA11 CA20 CA25 CL10	CA10 CAD11 CAD12	CA11 CA20 CA25	CA25	CA4 CA4-1	CA10 CAD11 CAD12	CA11	CA20	CA25		
	Max. no. of stages			Max. no. of stages		Max. no. of stages			No. of stages						
S									S_{min.}	H					
S = 46 1.81	3	1	-	1	1	1	2	-	44 1.73	21 .83	1/2	1/2	1/2	1/2	1
S = 50 1.97	3	1	1	2	1	2	2	1	46 1.81	26,5 1.04	3	3	-	-	2
S = 61 2.40	4	2	2	3	2	3	3	2	54 2.13	26,5 1.04	4	-	-	-	-
S = 67 2.64	5	2	2	3	2	3	3	2	56 2.20	-	-	-	3	3	-
S = 69 2.70	5	3 ²	3	4	3	4	4	3	60 2.36	-	-	-	-	-	3
									62 2.44	26,5 1.04	5	-	-	-	-
									66 2.60	-	-	4/5	-	-	-
									68 2.68	-	-	-	4	-	-
									70 2.76	26,5 1.04	6	-	-	4	-
									74 2.91	-	-	6	-	-	4

¹see page 51 ²not available for switch type CA20

Wall Mounting, Escutcheon Plates and Additional Length

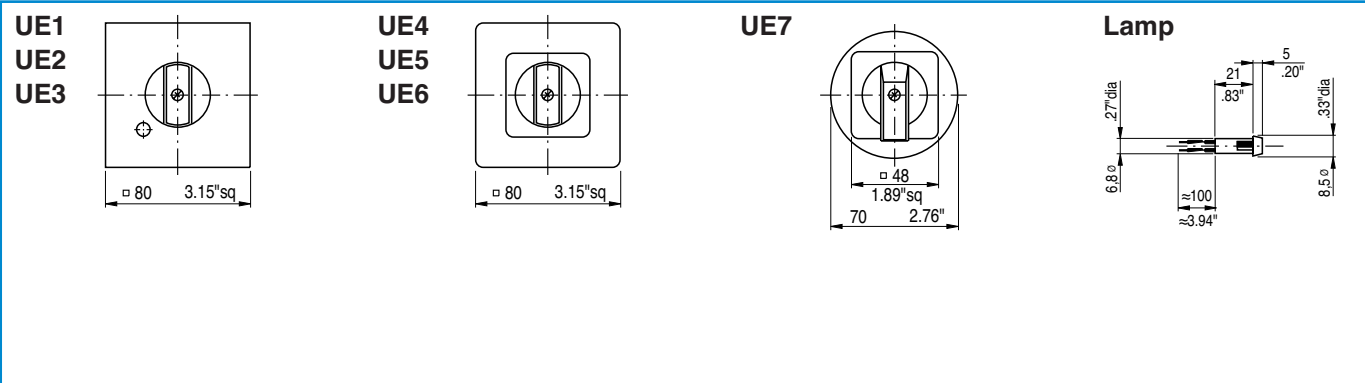

Escutcheon plates for mounting E, EF, ER, ERF, EG, EGF, KN1, KD1, KN2, EC, EC1, ED, ED1, VE, VE1, VF

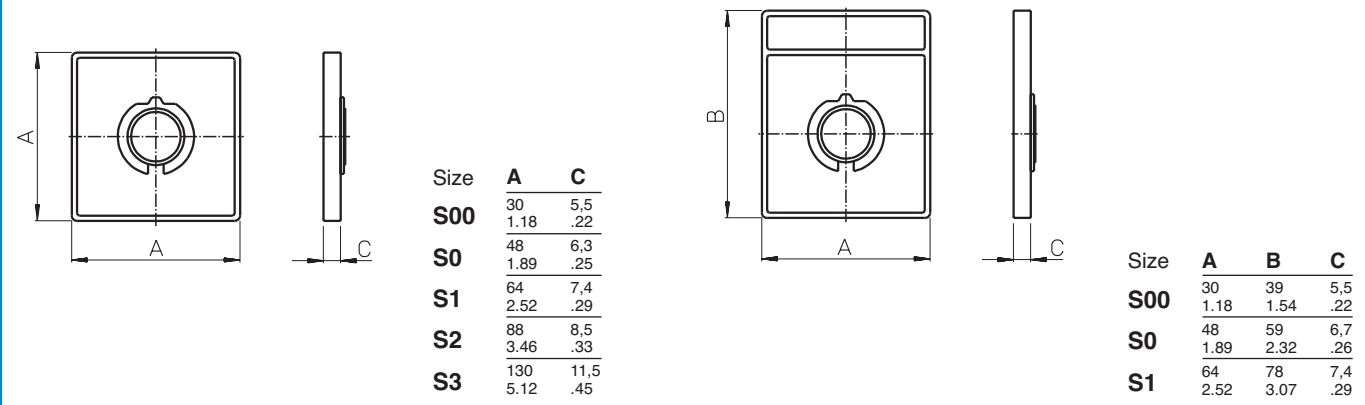

Additional length for amendment (page 4)

	CA10	CA11	CAD11	CA20	CAD12	CA25	C26	C32	C42
Latching mechanism size S1	5,4 .21	5,4 .21	-	-	-	-	-	-	-
Latching mechanism size S2	-	-	9,2 .36	9,2 .36	-	-	-	-	-
Snap action	14,3 .56	14,3 .56	12,2 .48	12,2 .48	12,2 .48	12,2 .48	12,2 .48	12,2 .48	12,2 .48

Quick connects for switches CA4-4

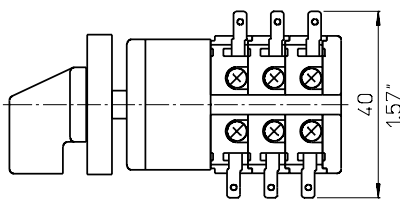

Additional Length

Terminal lugs for switches C315, C316 and L switches

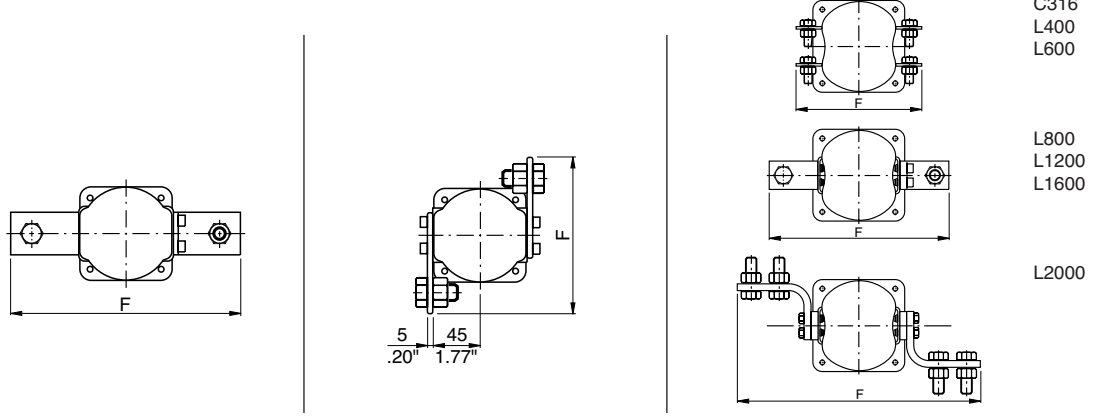

F	L350		L630		L1000		L1250		L351		L631		L1001		L1251		C315		C316		L400		L600		L800		L1200		L1600		L2000	
	mm	inch	mm	inch	mm	inch	mm	inch	mm	inch	mm	inch	mm	inch	mm	inch	mm	inch	mm	inch	mm	inch	mm	inch	mm	inch	mm	inch	mm	inch	mm	inch
	190	7.48	220	8.66	230	9.06	240	9.45	138	5.43	148	5.83	148	5.83	148	5.83	150	5.91	180	7.09	208	8.19	256	10.08	326	12.83						

Length L

Stages	CA4		CA10		CAD11		CA11		CA20		CA25		CA10B		CA11B		CA20B		CA25B		C26		C32		C42		C43		C80		C125		C315	
	CA4-1	CL4	CAD12	CL10	CA11	CA20	CA25	CA10B	CA11B	CA20B	CA25B	C26	C32	C42	C43	C80	Size S2	Size S3	L switches	L switches														
1	30 1.18	34 1.34	33,5 1.32	37,2 1.46	36,7 1.44	37,7 1.48	39 1.51	38,9 1.53	42,1 1.66	43,1 1.70	44,4 1.75	42 1.65	46,8 1.84	50,8 2.00	59 2.32	61,5 2.42	67,5 2.66	78,6 3.09																
2	38 1.50	46 1.81	43 1.69	49,9 1.96	49,4 1.94	50,4 1.98	53 2.09	48,4 1.91	54,8 2.16	55,8 2.20	58,4 2.30	54,7 2.15	64,3 2.51	72,3 2.85	80,5 3.17	88,0 3.46	100 3.94	117,2 4.61																
3	46 1.81	58 2.28	52,5 2.07	62,6 2.46	62,1 2.44	63,1 2.48	67 2.64	57,9 2.28	67,5 2.66	68,5 2.70	72,4 2.85	67,4 2.65	81,8 3.22	93,8 3.69	102 4.02	114,5 4.51	132,5 5.22	155,8 6.13																
4	54 2.13	70 2.76	62 2.44	75,3 2.96	74,8 2.94	75,8 2.98	81 3.19	67,4 2.65	80,2 3.16	81,2 3.20	86,4 3.40	80,1 3.15	99,3 3.91	115,3 4.54	123,5 4.86	141 5.55	165 6.50	194,4 7.65																
5	62 2.44	82 3.23	71,5 2.81	88 3.46	87,5 3.44	88,5 3.48	95 3.74	76,9 3.03	92,9 3.66	93,9 3.70	100,4 3.95	92,8 3.65	116,8 4.60	136,8 5.39	145 5.71	167,5 6.59	197,5 7.78	233 9.17																
6	70 2.76	94 3.70	81 3.19	100,7 3.96	100,2 3.94	101,2 3.98	109 4.29	86,4 3.40	105,6 4.16	106,6 4.20	114,4 4.50	105,5 4.15	134,3 5.29	158,3 6.23	166,5 6.56	194 7.64	230 9.06	271,6 10.69																
7	78 3.07	106 4.17	90,5 3.56	113,4 4.46	112,9 4.44	113,9 4.48	123 4.84	95,9 3.78	118,3 4.66	119,3 4.70	128,4 5.05	118,2 4.65	151,8 5.98	179,8 7.08	188 7.40	220,5 8.68	262,5 10.33	310,2 12.21																
8	86 3.39	118 4.65	100 3.94	126,1 4.96	125,6 4.94	126,6 4.98	137 5.39	105,4 4.15	131 5.16	132 5.20	142,4 5.60	130,9 5.15	169,3 6.67	201,3 7.93	209,5 8.25	247 9.72	295 11.61	348,8 13.73																
9	94 3.70	-	109,5 4.31	138,8 5.46	138,3 5.44	139,3 5.48	151 5.94	114,9 4.52	143,7 5.66	144,7 5.70	156,4 6.15	143,6 5.65	186,8 7.36	222,8 8.77	231 9.09	273,5 10.77	327,5 12.89	387,4 15.25																
10	-	-	119 4.68	151,5 5.96	151 5.94	152 5.98	165 6.50	124,4 4.90	156,4 6.16	157,4 6.20	170,4 6.70	156,3 6.15	204,3 8.04	244,3 9.62	252,2 9.54	300 11.81	360 14.17	426 16.77																
11	-	-	128,5 5.06	-	163,7 6.44	164,7 6.48	179 7.05	133,9 5.27	169,1 6.66	170,1 6.70	184,4 7.25	169 6.65	221,8 8.73	265,8 10.46	274 10.79	326,5 12.85	392,5 15.45	464,6 18.29																
12	-	-	138 5.43	-	176,4 6.94	177,4 6.98	193 7.60	143,4 5.65	181,8 7.16	182,8 7.20	198,4 7.80	181,7 7.15	239,3 9.42	287,3 11.31	295,5 11.63	353 13.90	425 16.73	503,2 19.81																

The Range of “Blue Line” Switchgear

Technical literature covering the following products is available on request.

	Catalog Number
Main Switches and Main Switches with Emergency Function 16 A-315 A Maintenance Switches 20 A-315 A Switch Disconnectors 20 A-315 A According to IEC 60947-3, EN 60947-3, VDE 0660 part 107, IEC 60204, EN 60204 and VDE 0113	500
CL Switches 10 A-20 A C, CA and CAD Switches 10 A-315 A and L Switches 350 A-2400 A C, CA and CAD switches are designed for universal application. They are recommended for instrument, isolator, double-throw and motor control. L switches are designed for load and off-load applications. They are used to switch resistive or low inductive loads.	100
Optional Extras and Enclosures The complete product line, a large number of optional extras is available, including door interlocks, push-pull devices, cylinder and padlock attachments, control and indicator devices, AC motor drives, as well as enclosures, both insulated and metal.	101
A and AD Switches 6 A-25 A A and AD switches have 4 contacts in each switching stage. These switches provide an extensive range of switch functions and require a minimum mounting depth. Up to 36 switching positions are possible, with availability of 48 contacts per 12 stage switch column.	110
CG, CH and CHR Switches 10 A-25 A Ultra compact CG, CH and CHR switches are ideally suited for control and instrumentation applications. Switch terminals are “finger-proof” and conveniently accessible for wiring and are delivered open. All CG4 switches offer specially designed gold plated contacts or H-bridges with “cross-wire” contact systems, which facilitates their use in electronic circuitry and chemically aggressive environments.	120
DH, DHR, DK and DKR Switches 6 A-16 A DH, DHR, DK and DKR switches incorporate unique corrosion resistant contacts that permit operation on system voltage as low as 1 V. They have fully enclosed and protected contacts which can be operated either by rotary and/or lateral handle movement. D switches are used in calibration and semiconductor circuits. They are also used for relay and contactor control.	130
X Switches 80 A-630 A X switches can be applied for load, tap and gang switching duties. They incorporate 6 contacts in each switching stage. Their compact design provides a minimum length dimension for mounting purposes.	140
KG Switches 20 A-315 A and KH and KHR Switches 16 A-80 A KG, KH and KHR switches are excellent circuit interruptors. They have high through fault and fault making capacities and are especially designed for use as isolators and safety switches for machine tools, distribution panels and switchboards. KG ON/OFF switches offer unusually high dimensioned air and creepage distances between terminals which are designed for time saving “straight-line” wiring. ON/OFF switches are available with up to 8 poles and double-throw switches are available with up to 4 poles.	150
Contactors 16 A-115 A and Motor Starters 1,1 kW-55 kW These include control relays, motor contactors, two and four pole output contactors, heating contactors, thermal overload relays.	200
Push Buttons and Pilot Lights, 22,5 mm Ø A complete range of state-of-the-art push buttons and pilot lights represent an ideal combination of functional security and economical efficiency in a modular design.	302

SALES AND SERVICE ORGANIZATION

Australia

australian solenoid Φ co.pty. ltd.

379 Liverpool Road, ASHFIELD, N.S.W. 2131
P. O. Box 1093, ASHFIELD, N.S.W. 1800
Tel: +61 2 9797-7333, Fax: 0092
e-mail: sales@austrasol.com.au

Austria

austro solenoid Φ ges.m.b.h.

Schumanngasse 35, Postfach 431
A-1181 WIEN
Tel: +43 1 404 06, Fax: 404 06-190
e-mail: aso@krausnaimer.com

Belgium, Luxembourg

solenoid benelux Φ b. v.

Stationstraat 34
B-3070 KORTENBERG
Tel: +32 2 757-0141, Fax: 1640
e-mail: info@solenoid.be

Brazil

solenoid do brasil Φ ltda.

Avenida Berna 230
04774-020 SAO PAULO
Tel: +55 11 5524-1288, Fax: 5521-4659/9633
e-mail: knbrasil@krausnaimer.com.br

Canada

canadian solenoid Φ inc.

219 Connie Crescent, Unit 13A
CONCORD, Ontario, L4K 1L4
Tel: +1 905 738-1666, Fax: 9327
e-mail: cdnsolenoid@cansol.on.ca

Chile

ASEA BROWN BOVERI S. A.
Vicuña Mackenna 1602, Casilla 3555
SANTIAGO DE CHILE
Tel: +56 2 544-7411, Fax: 7418

Cyprus

ELECTROMATIC CONSTRUCTIONS LTD.
72, Evagoras Pallikarides Str., CY-2235 LATSIA-Nicosia
P. O. Box 12630, CY-2251 LATSIA-Nicosia
Tel: +357 2 48 41 41, Fax: 48 57 47

Czech Republic

OBZOR, výrobní družstvo Zlín
Louky-Slanica 378
CZ-76413 ZLÍN
Tel: +420 57 7195-111/-153 (Techn. Supp.)
Fax: +420 57 7195-152/-138
e-mail: ots@obzor.cz

Denmark

C. THIIM A/S Ingeniørfirma
Transformervej 31
DK-2730 HERLEV
Tel: +45 44 85 80 00, Fax: 80 05
e-mail: thiim@thiim.com

Finland

suomen solenoid Φ oy

Karitie 7
FIN-01530 VANTAA
Tel: +358 9 825-4240, Fax: 42410
e-mail: etunimi.sukunimi@finsol.fi

France

solenoid france Φ s. a.

33, rue Bobillot
F-75013 PARIS
Tél: +33 1 58 40 80 80, Fax: 45 80 91 19
e-mail: sales@solfrance.fr

Germany

deutsche solenoid Φ vertriebs-gmbH

Wikingerstraße 20-28, D-76189 KARLSRUHE
Postfach 10 01 24, D-76231 KARLSRUHE
Tel: +49 721 59 88-0, Fax: 59 28 28
e-mail: desol@krausnaimer.com

Great Britain

u. k. solenoid Φ ltd.

115 London Road
NEWBURY/BERKSHIRE RG14 2AH
Tel: +44 1635 45991, Fax: 37807
e-mail: sales@uksol.co.uk

Greece

KALAMARAKIS-SAPOUNAS S. A.
Ionias & Neromilou Str., P. O. Box 46566
GR-13671 ACHARNES/ATHENS
Tel: +30 2 10 240-6000-6, Fax: 240-6007
e-mail: ksa@ksa.gr

Hungary

GANZ, Schalter- u. Geräterfabrik
X. Kőbányal út 41/c, Postfach 87
H-1475 BUDAPEST
Tel: +36 1 261-5479, Fax: 4685
e-mail: ganzkk@ganzkk.hu

Iceland

BRAEDURNIR ORMSSON EHF
Lágmúli 6-9, P. O. Box 8670
REYKJAVIK
Tel: +354 530-28 00, Fax: 28 10
e-mail: skuli@ormsson.is

Iran

RBS technische und kommerzielle
Beratungsgesellschaft mbH
Kohlriege 14
D-33758 SCHLOSS HOLTE
Tel: +49 5207 9111-0, Fax: 9111-19
e-mail: kontakt@rbs-gmbh.de

Republic of Ireland

irish solenoid Φ ltd.

Bay 145, Shannon Free Zone
SHANNON, Co. Clare
Tel: +353 61 704700, Fax: 471084
e-mail: salesirs@krausnaimer.ie

Italy

solenoid italia Φ s.r.l.

Via Terracini, 9
I-24047 TREVIGLIO (BG)
Tel: +39 0363-30 11 12, Fax: 30 21 13

Japan

solenoid japan Φ co. ltd.

Yoshiwada Building 2F
1-11-6 Hamamatsucho
Minato-Ku, TOKYO 105-0013
Tel: +81 3 3436-6151, Fax: 6325

Kuwait

AMMAR & PARTNERS ELECTRICAL CO.
P. O. Box 1871
13019 SAFAT
Tel: +965 483-0122/483-0133
Fax: +965 484-1818

Malaysia

INDUSTRIAL AUTOMATION (M) Sdn Bhd
30-3 & 30-4 Loke New Road
55200 KUALA LUMPUR
Tel: +60 3-9-2210511, Fax: 2222299
e-mail: inquiry@iasb.com.my

Mexico

ING. JAVIER CABALLERO B.
A. Gaviño 30, Satélite,
53100, Edo. de Mexico, MEXICO
Tel: +52 5555 62-7577, Fax: 0434
e-mail: j_caballero_b@infosel.net.mx

Netherlands

solenoid benelux Φ b. v.

Wegtersweg 38, Postbus 199
NL-7556 BR HENGEL0 (Ov.)
Tel: +31 74 291-9441, Fax: 8380
e-mail: info@solenoid.nl

New Zealand

new zealand solenoid Φ co. ltd.

42 Miramar Avenue, P. O. Box 15-009
WELLINGTON
Tel: +64 4 380-9888, Fax: 9877
e-mail: sales@nzsolenoid.co.nz

Norway

norsk solenoid Φ a/s

Hjalmar Brantings vei 8, P. O. Box 21, Økern
N-0508 OSLO
Tel: +47 22 64 44 20, Fax: 65 39 49
e-mail: nos@norsksol.no

Poland

ASTAT sp. z o.o.
ul. Dabrowskiego 461
PL-60451 POZNAŃ
Tel: +48 61 848-8871/72, Fax: 8276
e-mail: info@astat.com.pl

Portugal

ELECTRICOL-DAMAS, FERREIRA & DAMASCENO, S. A.
Apartado 1083
P-2671-852 SANTO ANTÓNIO DOS CAVALEIROS
Tel: +351 21 989-8939, Fax: 988-6464

Kingdom of Saudi-Arabia

HAWA ELECTRIC PANEL BOARD FACTORY
Industrial Area, P. O. Box 1684
DAMMAM 31441
Tel: +966 3 847-2061, Fax: 2056

Singapore

solenoid singapore Φ pte. ltd.

115A, Commonwealth Drive
03-17/23
SINGAPORE 149 596
Tel: +65 6473-8166, Fax: 8643
e-mail: krausnaimer@singsol.com.sg

Slovenia

SCHRACK Energietechnik d.o.o.
Glavni trg 47
SI-2380 SLOVENJ GRADEC
Tel: +386 2 88 392 00, Fax: 434 71
e-mail: schrack.sg@schrack-energietechnik.si

Republic of South Africa

south african solenoid Φ co.pty. ltd.

7 Village Crescent, Linbro Village
Linbro Business Park, SANDTON 2065
P. O. Box 511, KELVIN 2054
Tel: +27 11 608-6060, Fax: 608-2874
e-mail: sales@sasolenoid.co.za

Spain

HAZEMEYER ESPAÑOLA S. A.
Crta. de Tiana s/n, Esq. N-2
BADALONA-BARCELONA
Tel: +34 93 389-4262, Fax: 384-3586
e-mail: heshaze@catworld.net

Sweden

skandinaviska solenoid Φ ab

Dr. Widerströms Gata 11, FRUÅNGEN
Box 42097, S-126 14 STOCKHOLM
Tel: +46 8 97 00 80, Fax: 97 87 33
e-mail: order@skansol.se

Switzerland

AWAG Elektrotechnik AG
Sandbühlstraße 2, Postfach
CH-8604 VOLKETSCHWIL
Tel: +41 1 908-1919, Fax: 1999
e-mail: info@awag.ch

Taiwan

NUWTEC ENTERPRISE Co Ltd
No. 301, Sec. 1, Nan Kang Road
TAIPEI 115, Taiwan, R. o. C.
Tel: +886 2 265-13279, Fax: 13264
e-mail: nathan.nuwtec@msa.hinet.net

Turkey

ÜNAL KARDEŞ ELEKTRİK GEREÇLERİ A. Ş.
Beşyol, Eski Londra Asfaltı-6
TR-34630 SEFAKÖY-Istanbul
Tel: +90 212 624-9204, Fax: 592-4810
e-mail: info@unal kardes.com.tr

USA

american solenoid Φ co. inc.

760 New Brunswick Road, P. O. Box 430
SOMERSET, NJ 08873
Tel: +1 732 560-1240, Fax: 8823
e-mail: amsol@krausnaimer-us.com

